

1 Digital In/Ignition, 2 Digital Outputs Controller Controller with SAE J1939

USER MANUAL

P/N: AX032200

ACRONYMS

ACK	Positive Acknowledgement
CSR	CAN Status Report
DM	Diagnostic Message (from SAE J1939 standard)
DTC	Diagnostic Trouble Code
FMI	Failure Mode Identifier
OC	Occurrence Count
EA	Axiomatic Electronic Assistant (Service Tool for Axiomatic ECUs)
ECU	Electronic Control Unit (from SAE J1939 standard)
MAP	Memory Access Protocol
NAK	Negative Acknowledgement
PDU1	A format for messages that are to be sent to a destination address, either specific or global
PDU2	A format used to send information that has been labeled using the Group Extension technique and does not contain a destination address.
PGN	Parameter Group Number (from SAE J1939 standard)
PropB	Message that uses a Proprietary B PGN
SPN	Suspect Parameter Number (from SAE J1939 standard)

TABLE OF CONTENTS

GENERAL INFORMATION	4
1.1. INTRODUCTION TO AX032200 FEATURES	4
J1939 NETWORK – DIAGNOSTIC BROADCAST	6
1.2. CONTROL SOURCES	6
1.3. DIGITAL INPUT FUNCTION BLOCKS	6
1.3.1. Digital Input Functionality	6
1.3.2. Digital Input Type	7
1.3.3. Debounce Time	8
1.4. DIGITAL OUTPUT FUNCTION BLOCKS	9
1.4.1. Digital Output Override	9
1.4.2. Digital Output Enable	10
1.4.3. Digital Output Control	10
1.4.4. Digital Output Unlatch	11
1.4.5. Digital Output Diagnostic Parameters.....	11
1.5. MISCELLANEOUS	12
1.6. DIAGNOSTICS	12
1.7. CONSTANT DATA	14
1.8. MATH FUNCTION BLOCK	15
1.9. PROGRAMMABLE LOGIC FUNCTION BLOCK	16
1.10. LOOKUP TABLE FUNCTION BLOCK	16
1.11. CONDITIONAL BLOCK	17
1.12. SET / RESET LATCH FUNCTION BLOCK	19
1.13. CAN TRANSMIT FUNCTION BLOCK	19
1.14. CAN RECEIVE FUNCTION BLOCK	20
2. OVERVIEW OF J1939 FEATURES	22
2.1. INTRODUCTION TO SUPPORTED MESSAGES	22
2.2. J1939 NAME, ADDRESS AND SOFTWARE ID	23
2.2.1. J1939 Name.....	23
2.2.2. ECU Address	23
2.2.3. Software Identifier	24
3. ECU SETPOINTS ACCESSED WITH ELECTRONIC ASSISTANT	25
3.1. J1939 NETWORK SETPOINTS	25
3.2. DIGITAL INPUT SETPOINTS	25
3.3. DIGITAL OUTPUT SETPOINTS	26
3.4. MISCELLANEOUS SETPOINTS	28
3.5. DIAGNOSTIC SETPOINTS	28
3.6. CONSTANT DATA LIST SETPOINTS	29
3.7. MATH FUNCTIONAL BLOCK SETPOINTS	30
3.8. PROGRAMMABLE LOGIC BLOCK SETPOINTS	32
3.9. LOOKUP TABLE SETPOINTS	34
3.10. CONDITIONAL BLOCK SETPOINTS	36
3.11. SET-RESET LATCH BLOCK	37
3.12. CAN TRANSMIT SETPOINTS	38
3.13. CAN RECEIVE SETPOINTS	39
4. RE-FLASHING OVER CAN WITH ELECTRONIC ASSISTANT BOOTLOADER	40
4.1. PREREQUISITES	40
4.2. RE-FLASHING PROCEDURE	40
5. INSTALLATION INSTRUCTIONS	45
6. TECHNICAL SPECIFICATIONS	46
TECHNICAL DATASHEET #TDAX032200	ERROR! BOOKMARK NOT DEFINED.

GENERAL INFORMATION

1.1. Introduction to AX032200 Features

The AX032200 electronic control unit (ECU) is designed to provide a simple interface between J1939 CAN network and discrete electronic devices in a power generator set or industrial environment. The hardware supports 1 digital input or ignition, 2 digital outputs. Each of the two outputs have current feedback to the microprocessor.

The ECU has been designed to allow the maximum amount of versatility to optimize the performance of the machine. Numerous configurable variables, called setpoints, have been provided which are accessible using Axiomatic Technologies' Electronic Assistant. Information about the setpoint defaults and ranges is outlined in Section 4. The EA communicates with the controller over the J1939 CAN bus and uses Memory Access Protocol (MAP) to read/write each setpoint. Once the ECU has been setup as desired, the setpoints can be saved to a file, and flashed into other controllers over the CAN bus using EA.

The ECU is an arbitrary address capable ECU, which can perform dynamic address allocation at the run time. It also provides all necessary network support required by the J1939 standard.

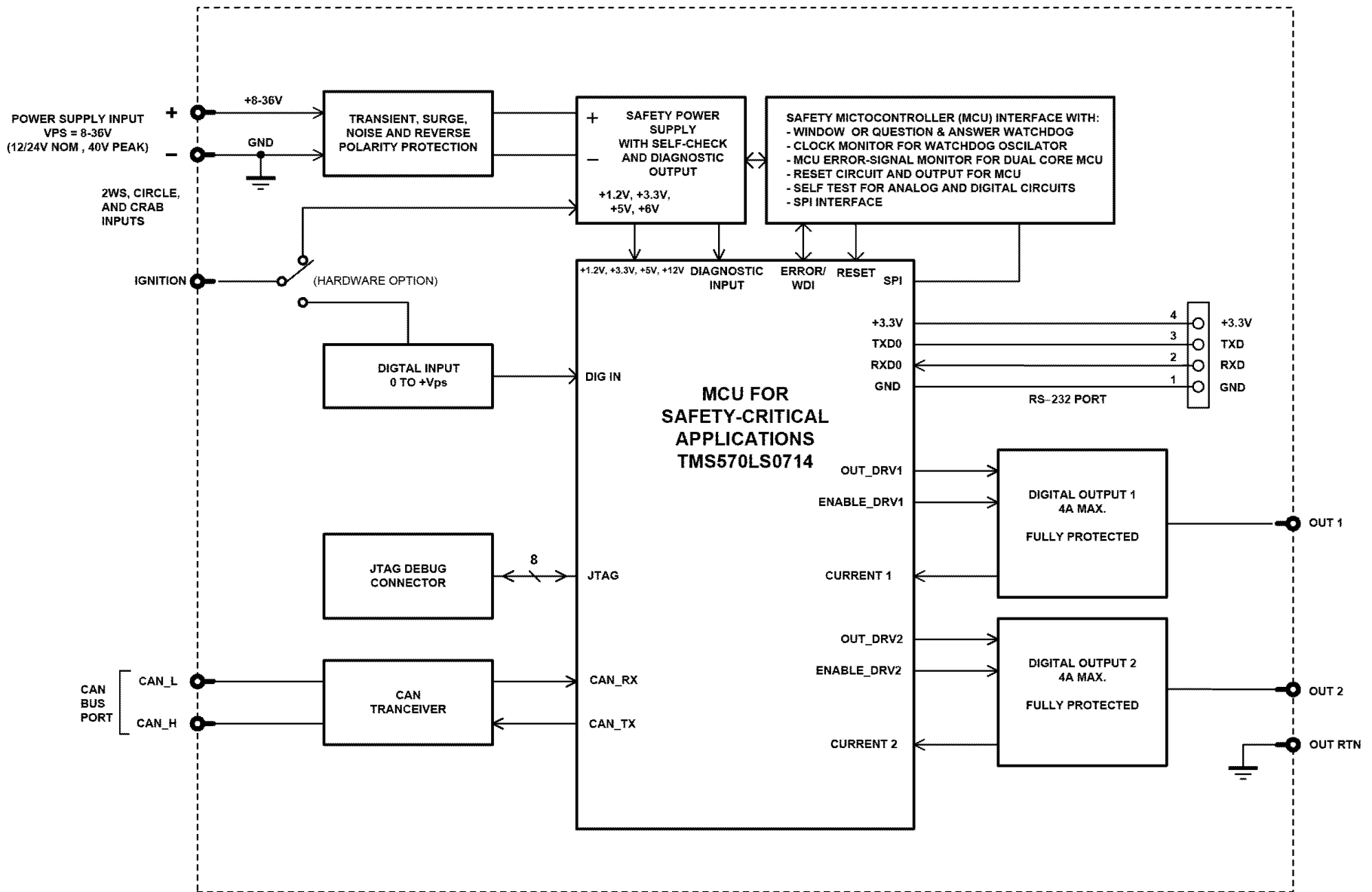

Figure 1. Block diagram

J1939 Network – Diagnostic Broadcast

Diagnostic messages are triggered by the internal function blocks and then broadcasted on the CAN bus network. However, in some applications this broadcast may not be required and so the user has the option to disable or enable this feature. Section 3.1 and Figure 16 show the configuration of this feature by using the Electronic Assistant tool.

1.2. Control Sources

The different function blocks in the ECU are commanded by a set of Control Sources. This section lists the different available control sources for these functions and their respective ranges.

Value	Meaning	Source Range
0	Control Not Used	[0]
1	Digital Input	[1]
2	Analog Input	1 - Output 1 Current Feedback (Amp) 2 - Output 2 Current Feedback (Amp) 3 - Power Supply Measured (V)
3	CAN Receive	[1...8]
4	Constant Data	[1...6]
5	Math Functional Block	[1...4]
6	Programmable Logic Block	[1...2]
7	Lookup Table	[1...6]
8	Conditional Logic Block	[1...10]
9	Set-Reset Latch	[1...3]
10	Digital Output Feedback	[1...2]

Table 1: Control Sources

1.3. Digital Input Function Blocks

The 1 digital input of the controller have signals going into the controller are interpreted as 0 or 1. The turn ON-signal (1) is reached at 12V input level while the turn OFF-signal (0) is reached at 0.8V input level. The discrete inputs can be used as control sources for digital outputs, as well as other logic blocks.

The Digital Input also can read either a Frequency/RPM or Pulse Width Modulated (PWM) input. For active inputs, a 10kΩ pull-up or pull-down resistor could also be connected at the input to handle open-collector NPN (active low, pull-up) or PNP (active high, pull-down) signals.

The sub sections below explain in more detail the functionality and available setpoints/parameters of the discrete inputs.

1.3.1. Digital Input Functionality

The Active High/Low parameter allows the user to select how the controller responds to the behaviour of the digital input. Table 2 shows the different Active High/Low options with the default being highlighted.

Value	Meaning
0	Active High
1	Active Low

Table 2: Active High/Low

By default, the inputs are configured to *Active High*, an ON response is achieved when the input is grounded.

An active high or low signal could be read by selecting the appropriate pull-up or pull-down 10kΩ resistor, as shown in the following table.

Value	Meaning
0	<i>Pullup/down Off</i>
1	<i>10kOhm Pullup</i>
2	<i>10kOhm Pulldown</i>

Table 3. Pullup/Pulldown Resistor Options

1.3.2. Digital Input Type

The Digital Input Type parameter allows for flexibility in the response of the input.

4	Frequency/RPM
5	PWM Duty Cycle

Table 4 shows the options available for this parameter.

Value	Meaning
0	Normal Logic
1	Inverse Logic
2	Latched Logic
3	Inverse Latched Logic
4	Frequency/RPM
5	PWM Duty Cycle

Table 4: Digital Input Types

By default, the *Normal Logic* type is used for the digital input.

In *Normal Logic* mode, the input state is 1 in case the input signal is interpreted as an ON-signal. The input state turns 0 if the input signal is interpreted as an OFF-signal.

For the *Inverse Logic* type, the opposite behavior applies. If the input signal is ON, the state turns 0 and if the input signal is OFF, the state turns 1.

Setting the Input to *Latched Logic*, the input state is toggled between 1 and 0 every time the input signal of the respective digital input changes from OFF to ON.

In *Inverse Latched Logic* mode, the opposite behavior applies. The input state toggles between 1 and 0 every time the input signal changes from ON to OFF.

In *Frequency/RPM* and *PWM Duty Cycle* modes “**Minimum Range**” and “**Maximum Range**” setpoints are available. They are used when the input is selected as a control input for another function block. They become the X_{min} and X_{max} values used in the slope calculations (see Equation 1). When these values are changed, other function blocks using the input as a control source are automatically updated to reflect the new X-axis values.

$$y = mx + a$$

$$m = \frac{Y_{max} - Y_{min}}{X_{max} - X_{min}}$$

$$a = Y_{min} - m * X_{min}$$

Equation 1. Linear Slope Calculations

In the case of the Output Control Logic function block, X and Y are defined as

X_{min} = Control Input Minimum Y_{min} = “**Output at Minimum Command**”
 X_{max} = Control Input Maximum Y_{max} = “**Output at Maximum Command**”

In all cases, while X-axis has the constraint that $X_{min} < X_{max}$, there is no such limitation on the Y-axis. Thus configuring “**Output At Minimum Command**” to be greater than “**Output At Maximum Command**” allows the output to follow the control signal inversely.

1.3.3. Debounce Time

The Digital Input Debounce Time parameter is a useful parameter in cases where the digital input signal coming into the controller is noisy. Figure 2 shows how the Debounce Time helps detect a correct input signal.

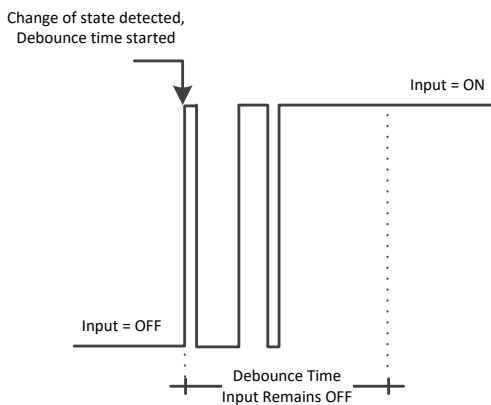

Figure 2: Digital Input Debounce Time

1.4. Digital Output Function Blocks

There are 2 digital outputs available in the ECU.

The Digital Outputs use various control sources to drive the output, each available from the listed sources in Table 1. The output will be controlled by these sources in the following order: **Override Source, Enable Source, Control Source, Unlatch Source**. Each output must have at least the control source active to be functional.

The following sub sections will explain in more detail the functionalities and available setpoints/parameters.

1.4.1. Digital Output Override

The **Override Source** will determine whether the relay output will be commanded by the **Control Source**. This Source has a higher priority than the Enable Source.

There are two different **Override Responses** in which the Override signal can be used. These responses are listed in Table 5, where the default value is highlighted.

Value	Meaning
0	Override When OFF
1	Override When ON

Table 5: Override Responses

When the **Override Response** is configured to *Override When ON*, the relay output will be commanded according to the signal of the **Control Source/Number** by the **Override State**. If the Override Response is set to *Override When OFF*, the relay output will be commanded according to the signal of the Control Source/Number by the Override State. Table 6 shows the two possible states for the **Override Response**.

Value	Meaning
0	Override State OFF
1	Override State ON

Table 6: Override State

In case of **Override State OFF**, the relay output switches to Normally Open. If **Override State ON** is configured, the relay output changes to Normally closed.

1.4.2. Digital Output Enable

The **Enable Source** will determine whether the relay output will be commanded by the **Control Source**. There are six different **Enable Responses** in which the enable signal can be used. These responses are listed in Table 7, where the default value is highlighted.

Value	Meaning
0	Enable When ON
1	Enable When OFF
2	Disable When ON
3	Disable When OFF
4	Enable When ON Else Keep State
5	Enable When OFF Else Keep State

Table 7: Enable Response

When the **Enable Response** is set to *Enable When ON* or *Disable When OFF*, the relay output will be commanded according to the signal of the **Control Source/Number** and the **Output Type** only when the signal of the **Enable Source/Number** is ON. Otherwise, the output is commanded to the OFF state (**Output Type** selected).

Similarly, when the **Enable Response** is set to *Enable When OFF* or *Disable When ON*, the output will be commanded according to the **Control Source/Control Number** and the **Output Type** only when the signal of the **Enable Source/Enable Number** is OFF. Otherwise, the output is commanded to the OFF state (**Output Type** selected).

In case the **Enable Response** is *Enable When ON Else Keep State*, the relay output will be commanded according to the signal of the **Control Source/Number** and the **Output Type** only when the signal of the **Enable Source/Number** is ON. If the Enable Source is OFF, the output will keep the previous state.

Likewise, when the **Enable Response** is configured to *Enable When OFF Else Keep State*, the relay output will be commanded according to the **Control Source/Number** and the **Output Type** only when the **Enable Source/Number** is OFF. Otherwise, the relay output holds the previous state.

A time delay for both states (ON, OFF) can be set by setting the **Enable Response Delay** parameter to true. The values of these time delays can be set with the parameters **Enable OFF Delay** and **Enable ON Delay**. In this case, the delays are valid for the enable state and the control state.

1.4.3. Digital Output Control

When the output is being commanded by the **Control Source**, the selected **Output Type** parameter determines what logic is used.

The **Output Type** parameter allows for flexibility in the response of the output. Table 8 shows the options available for this parameter.

Value	Meaning
0	<i>Output Not Implemented</i>
1	<i>Normal Logic</i>
2	<i>Inverse Logic</i>
3	<i>Latched Logic</i>
4	<i>Inverse Latched Logic</i>
5	<i>Toggle Logic</i>

Table 8: Output Type

By default, *Normal Logic* response is used for the outputs.

In *Normal Logic* response, if the source of the respective output is triggered ON, the output state will be ON.

In the case of *Inverse Logic* response, when the source of the respective relay output is triggered OFF, the output state will be ON.

In the case of *Latched Logic* response, every time the source of the respective output goes from OFF to ON, the output state will turn ON. The opposite behavior applies for the *Inverse Latched Logic*. If the output switches from ON to OFF, the output state changes.

The *Toggle Logic* lets the output toggle for a configured frequency. The time for switching from one state to the other state results the **Toggle Frequency** which is in milliseconds and by default 0ms.

1.4.4. Digital Output Unlatch

This source can only be configured if the Output Type is set to **Latched Logic** or **Inverse Latched Logic**. Is the state of the Unlatch Source normally closed, it turns the output state OFF in case the Output Type is set to **Latched Logic**. If the Unlatch Source state turns normally open afterwards, the output state stays OFF independent of the Output state before. The reverse behavior is valid for the **Inverse Latched Logic**.

1.4.5. Digital Output Diagnostic Parameters

The remaining parameters in this function block all pertain to the diagnostics related to each digital output, with more detail about diagnostic available in section 1.6.

When the output state is ON, all outputs are subject to open circuit faults, which are determined by the feedback current dropping below the set **On State Minimum Current**.

The low digital outputs can trigger overcurrent faults, which will occur when the feedback current rises above the set **On State Maximum Current**.

1.5. Miscellaneous

The Miscellaneous function block contains various parameters that affect the general diagnostic performance of the ECU.

The **Undervoltage Threshold**, **Overvoltage Threshold** setpoints are used to set the limits for when their respective diagnostic messages are triggered.

The **Current**, **Frequency**, **RPM** and **PWM Hysteresis** parameters are used to set the hysteresis values that affect when an input/output fault can be cleared.

Lastly, the **CAN Diagnostic Setting** parameter is used to control all diagnostics with one general setting. This can be used to disable diagnostics entirely, only transmit messages without a blank SPN, or transmit diagnostic messages normally.

1.6. Diagnostics

The Diagnostic function block includes faults, each representing a diagnostic message that the ECU can produce. Each Digital Output has a set of accompanying faults, all six outputs have an Open Circuit, Short To VCC, and Short To Ground fault. While the two low-sourced outputs have an additional Overcurrent fault. The remaining faults cover VPS Overvoltage and Undervoltage, Overtemperature, and other faults.

If and only if the **Event Generates a DTC in DM1** parameter is set to true will the other setpoints in the function block be enabled. They are all related to the data that is sent to the J1939 network as part of the DM1 message, Active Diagnostic Trouble Codes.

A Diagnostic Trouble Code (DTC) is defined by the J1939 standard as a 4-byte value which is a combination of:

SPN	Suspect Parameter Number	(first 19 bits of the DTC, LSB first)
FMI	Failure Mode Identifier	(next 5 bits of the DTC)
CM	Conversion Method	(1 bit, always set to 0)
OC	Occurrence Count	(7 bits, number of times the fault has happened)

In addition to supporting the DM1 message, the Controller also supports

DM2	Previously Active Diagnostic Trouble Codes	Sent only on request
DM3	Diagnostic Data Clear/Reset of Previously Active DTCs	Done only on request
DM11	Diagnostic Data Clear/Reset for Active DTCs	Done only on request

So long as even one Diagnostic function block has **Event Generates a DTC in DM1** set to true, the Controller will send the DM1 message every one second, regardless of whether there are any active faults, as recommended by the standard. While there are no active DTCs, the Controller will send the “No Active Faults” message. If a previously active DTC becomes inactive, a DM1 will be sent immediately to reflect this. As soon as the last active DTC goes inactive, it will send a DM1 indicating that there are no more active DTCs.

If there is more than one active DTC at any given time, the regular DM1 message will be sent using a multipacket Broadcast Announce Message (BAM). If the controller receives a request for a DM1

while this is true, it will send the multipacket message to the Requester Address using the Transport Protocol (TP).



At power up, the DM1 message will not be broadcast until after a 5 second delay. This is done to prevent any power up or initialization conditions from being flagged as an active error on the network.

The Diagnostic function block has a setpoint **Event Cleared Only by DM11**. By default, this is set to false, which means that as soon as the condition that caused an error flag to be set goes away, the DTC is automatically made Previously Active, and is no longer included in the DM1 message. However, when this setpoint is set to true, even if the flag is cleared, the DTC will not be made inactive, so it will continue to be sent on the DM1 message. Only when a DM11 has been requested will the DTC go inactive. This feature may be useful in a system where a critical fault needs to be clearly identified as having happened, even if the conditions that caused it went away.

In addition to all the active DTCs, another part of the DM1 message is the first byte, which reflects the Lamp Status. Each Diagnostic function block has the setpoint **Lamp Set by Event in DM1** which determines which lamp will be set in this byte while the DTC is active. The J1939 standard defines the lamps as *'Malfunction'*, *'Red Stop'*, *'Amber, Warning'* or *'Protect'*. By default, the *'Amber, Warning'* lamp is typically the one set by any active fault.

By default, every Diagnostic function block has associated with it a proprietary SPN. However, this setpoint **SPN for Event used in DTC** is fully configurable by the user should they wish it to reflect a standard SPN define in J1939-71 instead. If the SPN is change, the OC of the associate error log is automatically reset to zero.

Every Diagnostic function block also has associated with it a default FMI. The only setpoint for the user to change the FMI is **FMI for Event used in DTC**, even though some Diagnostic function blocks can have both high and low errors. In those cases, the FMI in the setpoint reflects that of the low-end condition, and the FMI used by the high fault will be determined per Table 10. If the FMI is changed, the OC of the associate error log is automatically reset to zero.

FMI for Event used in DTC – Low Fault	Corresponding FMI used in DTC – High Fault
FMI=1, Data Valid But Below Normal Operational Range – Most Severe Level	FMI=0, Data Valid But Above Normal Operational Range – Most Severe Level
FMI=4, Voltage Below Normal, Or Shorted To Low Source	FMI=3, Voltage Above Normal, Or Shorted To High Source
FMI=5, Current Below Normal Or Open Circuit	FMI=6, Current Above Normal Or Grounded Circuit
FMI=17, Data Valid But Below Normal Operating Range – Least Severe Level	FMI=15, Data Valid But Above Normal Operating Range – Least Severe Level
FMI=18, Data Valid But Below Normal Operating Range – Moderately Severe Level	FMI=16, Data Valid But Above Normal Operating Range – Moderately Severe Level
FMI=21, Data Drifted Low	FMI=20, Data Drifted High

Table 9: Low Fault FMI versus High Fault FMI



If the FMI used is anything other than one of those in Table 4, then both the low and the high faults will be assigned the same FMI. This condition should be avoided, as the log will still use different OC for the two types of faults, even though they will be reported the same in the DTC. It is the user's responsibility to make sure this does not happen.

When the fault is linked to a DTC, a non-volatile log of the occurrence count (OC) is kept. As soon as the controller detects a new (previously inactive) fault, it will start decrementing the **Delay Before Sending DM1** timer for the Diagnostic function block. If the fault has remained present during the delay time, then the controller will set the DTC to active, and it will increment the OC in the log. A DM1 will immediately be generated that includes the new DTC. The timer is provided so that intermittent faults do not overwhelm the network as the fault comes and goes, since a DM1 message would be sent every time the fault shows up or goes away.

Diagnostic Name	SPN	FMI	Meaning
Input 1 Range Low	6370	1	Input signal Below Minimum Range
Input 1 Range High	6371	0	Input signal Above Maximum Range
Output 1 Open Circuit	6372	5	Current Below Normal or Open Circuit
Output 1 Over Current	6373	6	Current Above Normal or Grounded Circuit
Output 2 Open Circuit	6374	5	Current Below Normal or Open Circuit
Output 2 Over Current	6375	6	Current Above Normal or Grounded Circuit
Power Supply Undervoltage	168	4	Voltage Below Normal or Shorted to Low Source
Power Supply Overvoltage	168	3	Voltage Above Normal or Shorted to High Source
Flash Checksum Error	8621	31	Condition Exists
Lockstep, Flash ECC, RAM ECC Single-bit, Double-bit Error	629	2	Data Erratic, Intermittent or Incorrect

In the case of Lockstep / Flash ECC / RAM ECC Single- and Double-bit Error faults; these faults are triggered by internal computations within the microcontroller's dual core. The entire Flash where the firmware resides is calculated with ECC (Error Correction Code). If there is any discrepancy in data in this Flash area, then a fault is triggered. Similarly, the RAM is also calculated with ECC to ensure data allocated is properly managed. Any discrepancy will trigger a fault. With respect to Lockstep error detection, both cores of TMS570LS0714 are running in parallel and validating each other. If there is any single- or double-bit fault discrepancy between both cores then a fault is triggered. Any of these faults will trigger a DM1 with SPN 629 and FMI 2.

1.7. Constant Data

The Constant Data Block contains four configurable constant data setpoints which can be used as a control source for other functions. While they are available as a control source to all functions, it is recommended not to use constant data as a control source for the Set-Reset Latch Block or Global Constant Signals 0/1 could be used.

1.8. Math Function Block

There are four mathematical function blocks that allow the user to define basic algorithms. A math function block can take up to six input signals. Each input is then scaled according to the associated limit and scaling setpoints.

Inputs are converted into percentage value based on the “**Input X Minimum**” and “**Input X Maximum**” values selected. For additional control the user can also adjust the “**Input X Decimal Digits**” setpoint to increase the resolution of the input data and the min and max values.

A mathematical function block includes three selectable functions, in which each implements equation A operator B, where A and B are function inputs and operator is function selected with a setpoint “**Math Function X**”. Setpoint options are presented in Table 10. The functions are connected, so that result of the preceding function goes into Input A of the next function. Thus Function 1 has both Input A and Input B selectable with setpoints, where Functions 2 to 4 have only Input B selectable. Input is selected by setting “**Function X Input Y Source**” and “**Function X Input Y Number**”. If “**Function X Input B Source**” is set to 0 ‘Control not used’ signal goes through function unchanged.

$$\text{Math Block Output} = \left(\left((A1 \text{ op1 } B1) \text{ op2 } B2 \right) \text{ op3 } B3 \right) \text{ op4 } B4$$

0	=, True when InA equals InB
1	!=, True when InA not equal InB
2	>, True when InA greater than InB
3	>=, True when InA greater than or equal InB
4	<, True when InA less than InB
5	<=, True when InA less than or equal InB
6	OR, True when InA or InB is True
7	AND, True when InA and InB are True
8	XOR, True when either InA or InB is True, but not both
9	+, Result = InA plus InB
10	-, Result = InA minus InB
11	x, Result = InA times InB
12	/, Result = InA divided by InB
13	MIN, Result = Smallest of InA and InB
14	MAX, Result = Largest of InA and InB

Table 10: Math function X Operator Options

For logic operations (6, 7, and 8) scaled input greater than or equal to 1 is treated as TRUE. For logic operations (0 to 8), the result of the function will always be 0 (FALSE) or 1 (TRUE). For the arithmetic functions (9 to 14), it is recommended to scale the data such that the resulting operation will not exceed full scale (0 to 100%) and saturate the output result.

When dividing, a zero divider will always result in a 100% output value for the associated function. Lastly the resulting mathematical calculation, presented as a percentage value, can be scaled into the appropriate physical units using the “**Math Output Minimum Range**” and “**Math Output Maximum Range**” setpoints. These values are also used as the limits when the Math Function is selected as the input source for another function block.

1.9. Programmable Logic Function Block

The Programmable Logic Function Block is a powerful tool. Programmable Logic can be linked to up to three Lookup Tables, any of which would be selected only under given conditions. Thus, the output of a Programmable Logic at any given time will be the output of the Lookup Table selected by the defined logic. Therefore, up to three different responses to the same input, or three different responses to different inputs, can become the input to another function block.

To enable any one of the Programmable Logic blocks, the “**Logic Enabled**” setpoint must be set to ‘True’. By default, all Logic blocks are disabled.

The three associated tables are selected by setting “**Table Number X**” setpoint to desired Lookup Table number, for example selecting 1 would set Lookup Table 1 as TableX.

For each TableX there are three conditions that define the logic to select the associated Lookup Table as Logic output. Each condition implements function $Argument1 Operator Argument2$ where Operator is logical operator defined by setpoint “**Table X – Condition Y Operator**”. Setpoint options are listed in Table 11. Condition arguments are selected with “**Table X – Condition Y Argument Z Source**” and “**Table X – Condition Y Argument Z Number**” setpoints. If ‘0 – Control not Used’ option is selected as “**Table x – Condition Y Argument Z Source**” the argument is interpreted as 0.

0	=, Equal
1	!=, Not Equal
2	>, Greater Than
3	>=, Greater Than or Equal
4	<, Less Than
5	<=, Less Than or Equal

Table 11: Table X – Condition Y Operator Options

The three conditions are evaluated and if the result satisfies logical operation defined with “**Logical Operator X**” setpoint, given in Table 12, the associated Lookup Table is selected as output of the Logical block. Option ‘0 – Default Table’ selects associated Lookup Table in all conditions.

0	Default Table (Table1)
1	Cnd1 And Cnd2 And Cnd3
2	Cnd1 Or Cnd2 Or Cnd3
3	(Cnd1 And Cnd2) Or Cnd3
4	(Cnd1 Or Cnd2) And Cnd3

Table 12: Table X – Conditions Logical Operator Options

The three logical operations are evaluated in order and the first to satisfy gets selected, thus if Table1 logical operation is satisfied, the Lookup Table associated with Table1 gets selected regardless of two other logical operations. In addition, if none of the logical operations is satisfied the Lookup Table associated with Table1 gets selected.

1.10. Lookup Table Function Block

Lookup Tables are used to give output response up to 10 slopes per input. If more than 10 slopes are required, A Programmable Logic Block can be used to combine up to three tables to get 30 slopes as described in Section 0.

Lookup tables have two differing modes defined by “**X-Axis Type**” setpoint, given in Table 13. Option ‘0 – Data Response’ is the normal mode where block input signal is selected with the “**X-**

Axis Source” and **“X-Axis Number”** setpoints and X values present directly input signal values. With option ‘1 – Time Response’ the input signal is time and X values present time in milliseconds. And selected input signal is used as digital enable.

0	<i>Data Response</i>
1	<i>Time Response</i>

Table 13: X-Axis Type Options

The slopes are defined with (x, y) points and associated point response. X value presents input signal value and Y value corresponding Lookup Table output value. “PointN – Response” setpoint defines type of the slope from preceding point to the point in question. Response options are given in Table 14. ‘Ramp To’ gives a linearized slope between points, whereas ‘Jump to’ gives a point to point response, where any input value between X_{N-1} and X_N will result Lookup Table output being Y_N . “Point0 – Response” is always ‘Jump To’ and cannot be edited. Choosing ‘Ignored’ response causes associated point and all the following points to be ignored.

0	<i>Ignore</i>
1	<i>Ramp To</i>
2	<i>Jump To</i>

Table 14: PointN – Response Options

The X values are limited by minimum and maximum range of the selected input source if the source is a Math Function Block. For the fore mentioned sources X-Axis data will be redefined when ranges are changed, therefore inputs should be adjusted before changing X-Axis values. For other sources Xmin and Xmax are -100000 and 1000000. The X-Axis is constraint to be in rising order, thus value of the next index is greater than or equal to preceding one. Therefore, when adjusting the X-Axis data, it is recommended that X_{10} is changed first, then lower indexes in descending order.

$$X_{min} \leq X_0 \leq X_1 \leq X_2 \leq X_3 \leq X_4 \leq X_5 \leq X_6 \leq X_7 \leq X_8 \leq X_9 \leq X_{10} \leq X_{max}$$

The Y-Axis has no constraints on the data it presents, thus inverse, decreasing, increasing or other response can be easily established. The Smallest of the Y-Axis values is used as Lookup Table output min and the largest of the Y-Axis values is used as Lookup Table output max (i.e., used as Xmin and Xmax values in linear calculation, Section 1.3.2). Ignored points are not considered for min and max values.

1.11. Conditional Block

The Conditional Block compares up to four different input sources with different logical or relational operators. The result of each block can therefore only be true (1) or false (0). Figure 3 demonstrates the connections between all parameters.

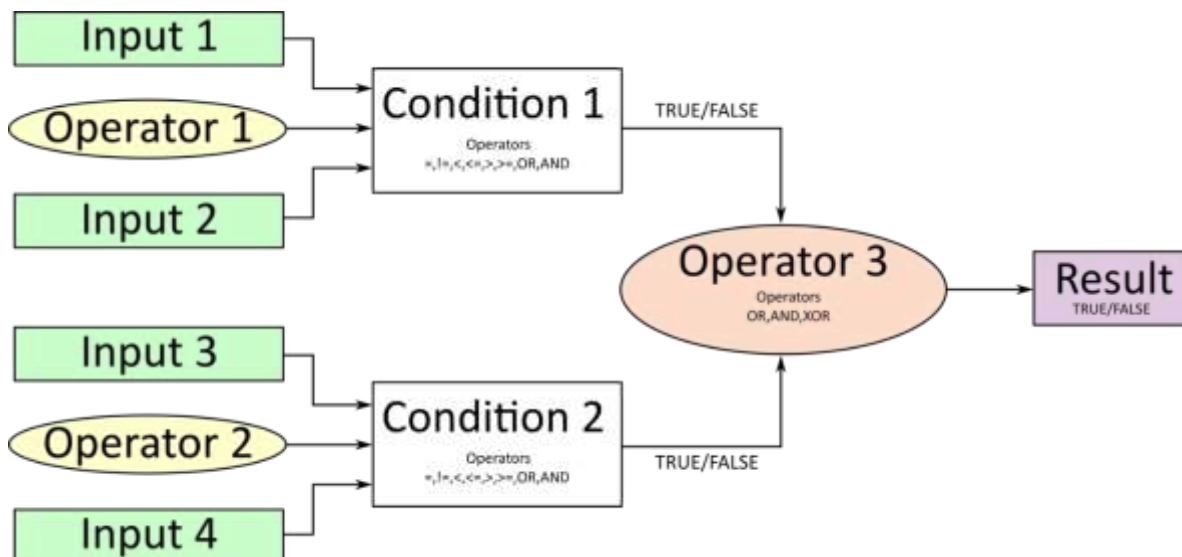

Figure 3: Conditional Block Diagram

Each Conditional Block offers two conditions. Both compare two inputs, which can hold a logical value or an integer value. The output of the conditions can only be true or false and will be compared by Operator 3 with a logical operator. This comparison is the result of the Conditional Block and can control any output source.

value of each source will then be compared to each other with an operator of Table 15. If no source is selected, the output value of an Input will be zero.

Value	Meaning
0	==, True when Argument 1 is equal to Argument 2
1	!=, True when Argument 1 is not equal to Argument 2
2	>, True when Argument 1 is greater than Argument 2
3	>=, True when Argument 1 is greater than Argument 2
4	<, True when Argument 1 is less than Argument 2
5	<=, True when Argument 1 is less than or equal Argument 2
6	OR, True when Argument 1 or Argument 2 is True
7	AND, True when Argument 1 and Argument 2 are True

Table 15: Input Operator Options

Operator 1 and Operator 2 are configured to OR by default. The table above cannot be used for comparing the conditions because they can only be compared with logical operators, which are listed in Table 16.

Value	Meaning
0	OR, True when Argument 1 or Argument 2 is True
1	AND, True when Argument 1 and Argument 2 are True
2	XOR, True when Argument 1 is not equal to Argument 2

Table 16: Condition Operator Options

If only one condition is used, it is to make sure that Operator 3 is set to **OR** so that the result is based solely on the condition which has been chosen.

1.12. Set / Reset Latch Function Block

Set-Reset Block consists of only 2 control sources: **Reset Source** and **Set Source**. The purpose of these blocks is to simulate a modified latching function in which the 'Reset Signal' has more precedence. The 'latching' function works as per the Table 18 below.

'Set Signal'	'Reset Signal'	'Set-Reset Block Output' (Initial State: <i>OFF</i>)
<i>OFF</i>	<i>OFF</i>	<i>Latched State</i>
<i>OFF</i>	<i>ON</i>	<i>OFF</i>
<i>ON</i>	<i>OFF</i>	<i>ON</i>
<i>ON</i>	<i>ON</i>	<i>OFF</i>

Table 17 – Set-Reset Function block operation

The **Reset** and **Set** sources have associated with them a minimum and maximum threshold values which determine the ON and OFF state. For the **Reset Source** are **Reset Minimum Threshold** and **Reset Maximum Threshold**. Similarly, for the **Set Source** are **Set Minimum Threshold** and **Set Maximum Threshold**. These setpoints also allow to have a dead band in between ON/OFF states and they are in terms of percentage of input selected.

As seen in Table 18 above, the 'Reset Signal' has more precedence over the 'Set Signal' - if the state of 'Reset Signal' is *ON*, the state of 'Set-Reset Block Output' will be *OFF*. To create an *ON* state in 'Set-Reset Block Output' the state of 'Reset Signal' must be *OFF* while the state of 'Set Signal' is *ON*. In this case, the state of 'Set-Reset Block Output' will remain *ON* even if 'Set Signal' turns *OFF* as long as 'Reset Signal' remains *OFF*. As soon as the 'Reset Signal' turns *ON* the 'Set-Reset Block Output' will turn *OFF* regardless of the state of 'Set Signal'.

1.13. CAN Transmit Function Block

The ECU provides up to 13 fully configurable CAN Transmit messages. Each block has its own **PGN**. Different transmit messages that share a PGN will be broadcast together as one message.

The CAN transmit message is always enabled and the **Repetition Rate** defines which time in milliseconds the CAN transmit message is repeated. The CAN message will not transmit on the J1939 network in case all CAN transmits have the same PGN and the **Repetition Rate** of the first CAN transmit is set to zero. In the case of shared PGNs the rate of the lowest number CAN Transmit is used, i.e. if CAN Transmit 1 and CAN Transmit 4 share a PGN, the Repetition Rate of CAN Transmit 1 is used.

The CAN Transmit messages can be sent on any Proprietary A or B PGN as broadcast messages. By default, the **Message Priority** is set to 6 (low priority).

The **Destination Address** of the J1939 Identifier can be changed to any value between 0...255.

The **Data Size**, **Data Index in Array (LSB)**, **Bit Index in Byte (LSB)**, **Resolution**, and **Offset** can all be used to map any SPN supported message by the J1939 standard from any **Data Source/Number** of the Transmit Function Block.

1.14. CAN Receive Function Block

The ECU supports up to 8 unique fully configurable CAN Receive Messages. The CAN Receive function block is designed to take any SPN from the J1939 network and use it as a **Control Source** for any relay outputs or CAN transmits.

The **Receive Message Enabled** is the most important setpoint associated with this function block and it should be selected first. Changing it will result in other setpoints being enabled/disabled as appropriate. By default, all receive messages are disabled.

Once a message has been enabled, a Lost Communication fault will be flagged if that message is not received within the **Receive Message Timeout** period if this has been set to 10ms or higher. This will trigger a Lost Communication event and the output data of the CAN Receive message will be set to 0. To avoid timeouts (if set to 10ms or higher) on a heavily saturated network, it is recommended to set the period at least three times longer than the expected update rate. To disable the timeout feature, simply set this value to zero, in which case the received message will never timeout and will never trigger a Lost Communication event.

By default, all control messages are expected to be sent to the ECU on Proprietary B PGNs. However, should a PDU1 message be selected, the ECU can be configured to receive it from any ECU by setting the **Specific Address that sends the PGN** to the Global Address (0xFF). If a specific address is selected instead, then any other ECU data on the PGN will be ignored.

The **Data Size**, **Data Index in Array (LSB)**, **Bit Index in Byte (LSB)**, **Resolution** and **Offset** can all be used to map any SPN supported by the J1939 standard to the output data of the Received function block.

The **Data Min** (Off Threshold) and **Data Max** (On Threshold) setpoints determine the minimum and maximum values of the control signal. As the names imply, they are also used as the ON/OFF thresholds for digital level types. These values are in whatever units the incoming data is **after** the resolution and offset are applied to the CAN Receive signal.

To have a CAN Receive message trigger, a relay output ON or OFF is to make sure the **Data Min (OFF Threshold)** and **Data Max (ON Threshold)** parameters are adjusted to the user's application. When the CAN Receive message (after having the resolution and offset applied to it), anything at **Data Max (ON Threshold)** parameter or higher, will trigger an ON command. Similarly, anything at **Data Min (OFF Threshold)** parameter or lower will trigger an OFF command. Any data in between will not change the state, thus providing a hysteresis. Figure 4 illustrates this behaviour.

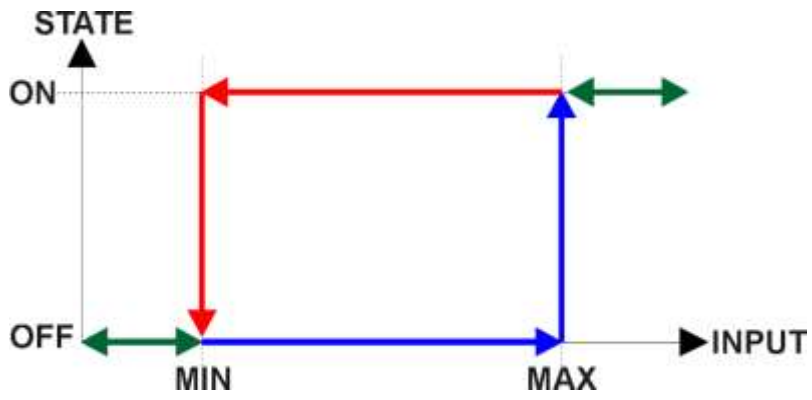

Figure 4: CAN Receive Message to Digital Output State

2. OVERVIEW OF J1939 FEATURES

The software was designed to provide flexibility to the user with respect to messages sent to and from the ECU by providing:

- Configurable ECU Instance in the NAME (to allow multiple ECUs on the same network)
- Configurable Transmit PGN and SPN Parameters
- Configurable Receive PGN and SPN Parameters
- Sending DM1 Diagnostic Message Parameters
- Reading and reacting to DM1 messages sent by other ECUs
- Diagnostic Log, maintained in non-volatile memory, for sending DM2 messages

2.1. Introduction To Supported Messages

The ECU is compliant with the standard SAE J1939, and supports the following PGNs

From J1939-21 - Data Link Layer

- | | |
|--|------------------|
| • Request | 59904 (\$00EA00) |
| • Acknowledgment | 59392 (\$00E800) |
| • Transport Protocol – Connection Management | 60416 (\$00EC00) |
| • Transport Protocol – Data Transfer Message | 60160 (\$00EB00) |
| • PropB Transmit, Default Digital I/O State Feedback | 65280 (\$00FF00) |
| • PropB Receive, Default Control Source Data Message | 65408 (\$00FF80) |
| • PropB Receive, Default Control Source Data Message | 65409 (\$00FF81) |
| • PropB Receive, Default Control Source Data Message | 65410 (\$00FF82) |
| • PropB Receive, Default Control Source Data Message | 65411 (\$00FF83) |
| • PropB Receive, Default Control Source Data Message | 65412 (\$00FF84) |
| • PropB Receive, Default Control Source Data Message | 65413 (\$00FF85) |
| • PropB Receive, Default Control Source Data Message | 65414 (\$00FF86) |
| • PropB Receive, Default Control Source Data Message | 65415 (\$00FF87) |

Note: Any Proprietary B PGN in the range 65280 to 65535 (\$00FF00 to \$00FFFF) can be selected

Note: The Proprietary A PGN 61184 (\$00EF00) can also be selected for any CAN Receive or CAN Transmit messages.

From J1939-73 - Diagnostics

- | | |
|--|------------------|
| • DM1 – Active Diagnostic Trouble Codes | 65226 (\$00FECA) |
| • DM2 – Previously Active Diagnostic Trouble Codes | 65227 (\$00FECB) |
| • DM3 – Diagnostic Data Clear/Reset for Previously Active DTCs | 65228 (\$00FECC) |
| • DM11 – Diagnostic Data Clear/Reset for Active DTCs | 65235 (\$00FED3) |
| • DM14 – Memory Access Request | 55552 (\$00D900) |
| • DM15 – Memory Access Response | 55296 (\$00D800) |
| • DM16 – Binary Data Transfer | 55040 (\$00D700) |

From J1939-81 - Network Management

- | | |
|--------------------------------|------------------|
| • Address Claimed/Cannot Claim | 60928 (\$00EE00) |
| Commanded Address | 65240 (\$00FED8) |

From J1939-71 – Vehicle Application Layer

- Software Identification

65242 (\$00FEDA)

None of the application layer PGNs are supported as part of the default configurations, but they can be selected as desired for either transmit or received function blocks.

Setpoints are accessed using standard Memory Access Protocol (MAP) with proprietary addresses. The Electronic Assistant (EA) allows for quick and easy configuration of the unit over the CAN network.

2.2. J1939 Name, Address and Software ID

The controller has a J1939 name which is broadcasted at power up and/or when its ECU Address has been changed. The Software ID PGN gives useful information regarding the controller.

2.2.1. J1939 Name

The ECU has the following defaults for the J1939 Name. The user should refer to the SAE J1939/81 standard for more information on these parameters and their ranges.

Arbitrary Address Capable	Yes
Industry Group	0, Global
Vehicle System Instance	0
Vehicle System	0, Non-specific system
Function	127, Axiomatic I/O Controller
Function Instance	1, AX032200, 1 Digital Input/Ignition, 2 Digital Outputs Controller
ECU Instance	0, First Instance
Manufacture Code	162, Axiomatic Technologies Corporation
Identity Number	Variable, uniquely assigned during factory programming for each ECU

The ECU Instance is a configurable setpoint associated with the NAME. Changing this value will allow multiple ECUs of this type to be distinguishable by other ECUs (including the Electronic Assistant) when they are all connected on the same network.

2.2.2. ECU Address

The default value of this setpoint is 128 (0x80), which is the preferred starting address for self-configurable ECUs as set by the SAE in J1939 tables B3 to B7. The EA will allow the selection of any address between 0 to 253, and ***it is the user's responsibility to select an address that complies with the standard.*** The user must also be aware that since the unit is arbitrary address capable, if another ECU with a higher priority NAME contends for the selected address, the controller will continue select the next highest address until it finds one that it can claim. See J1939/81 for more details about address claiming.

2.2.3. Software Identifier

PGN 65242	Software Identification	- SOFT
Transmission Repetition Rate:	On request	
Data Length:	Variable	
Extended Data Page:	0	
Data Page:	0	
PDU Format:	254	
PDU Specific:	218 PGN Supporting Information:	
Default Priority:	6	
Parameter Group Number:	65242 (0xFEDA)	
Start Position	Length	Parameter Name
1	1 Byte	Number of software identification fields
2-n	Variable	Software identification(s), Delimiter (ASCII “**”) 234
		SPN
		965
		234

For the ECU, Byte 1 is set to 1, and the identification fields are as follows

(Version)*

EA shows all this information in “General ECU Information”, as shown below

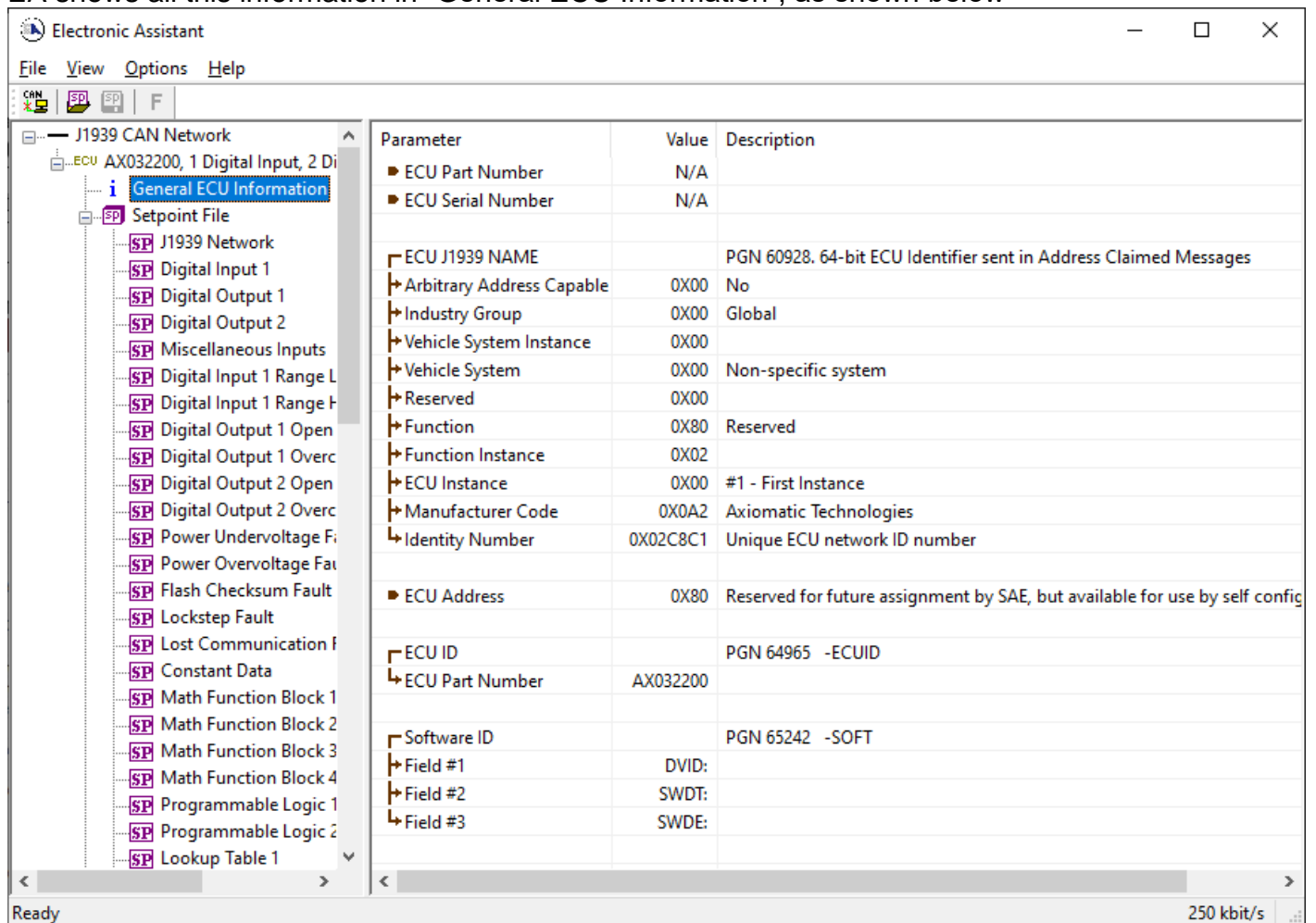

Note: The information provided in the Software ID is available for any J1939 service tool which supports the PGN -SOFT.

3. ECU SETPOINTS ACCESSED WITH ELECTRONIC ASSISTANT

Many setpoints have been reference throughout this manual. This section describes in detail each setpoint, their defaults and ranges. For more information on how each setpoint is used by the ECU, refer to the relevant section of the User Manual.

3.1. J1939 Network Setpoints

The J1939 Network setpoints deal with the setpoints such as *ECU Instance Number* and *ECU Address*. Figure 5 and Table 18 below will explain these setpoints and their ranges.

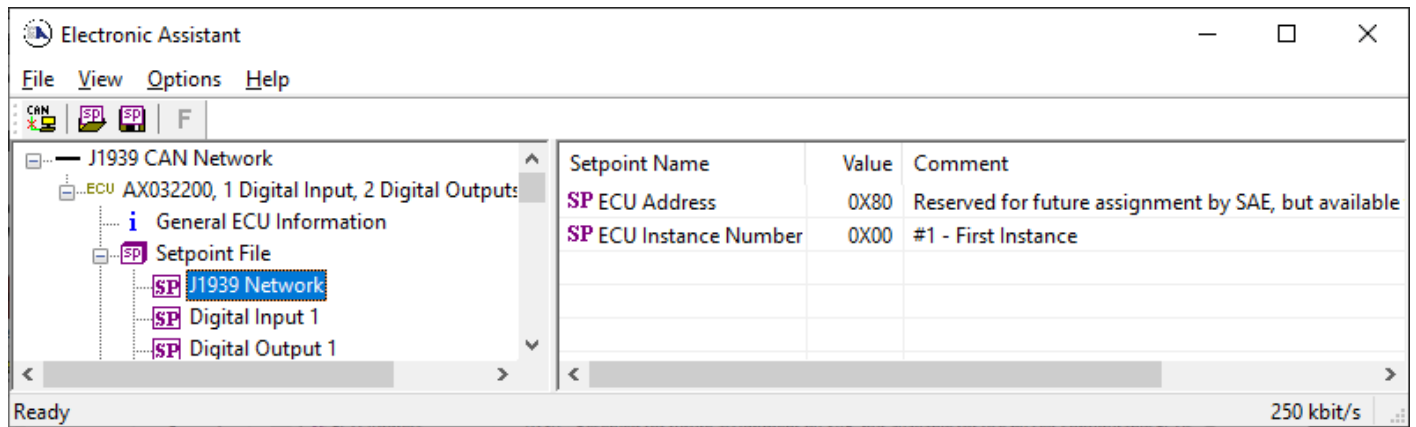

Figure 5: Screen Capture of Default J1939 Network Setpoints

Name	Range	Default	Notes
ECU Address	0 to 253	128 (0x80)	Preferred address for a self-configurable ECU
ECU Instance Number	Drop List	0, #1 – First Instance	Per J1939-81

Table 18: Default J1939 Network Setpoints

3.2. Digital Input Setpoints

The Digital Input setpoints are defined in section 1.3. Refer to that section for detailed information on how these setpoints are used. The screen capture below in Figure 6 displays the available setpoints for each of the Digital Inputs. Table 19 below highlights the allowable ranges for each setpoint.

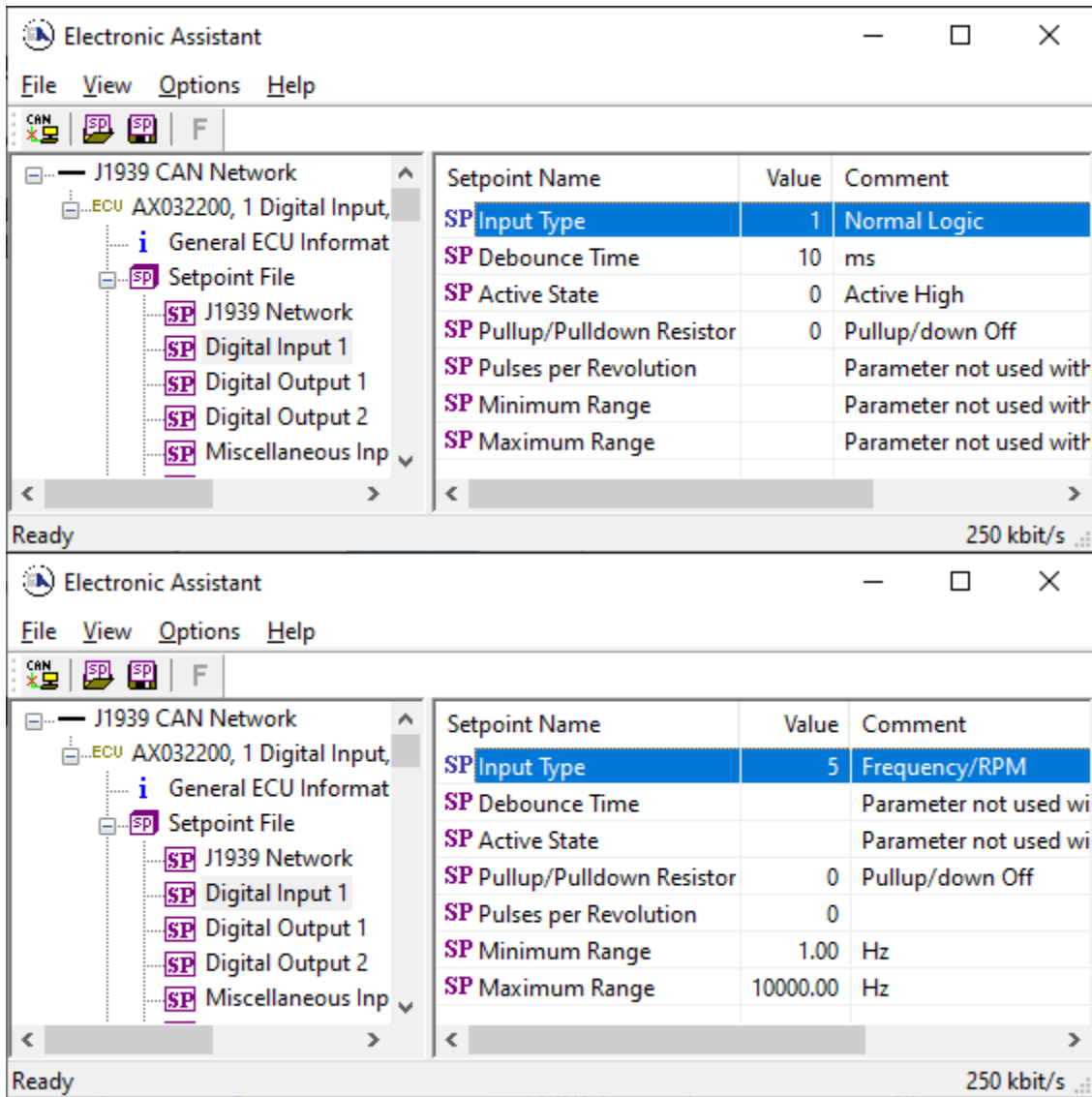

Figure 6: Screen Capture of Default Digital Input Setpoints

Name	Range	Default	Notes
Input Type	Drop List	Normal Logic	Refer to Section 1.3.2
Debounce Time	0...65,000	10	Units in [milliseconds]
Active State	Drop List	Active High	
Pulse per Revolution	0 to 1000	0	
Pullup/Pulldown Resistor	Drop List	0, Pullup/down Off	See Table 3
Minimum Range	Minimum Range	Per Type	
Maximum Range	Maximum Range	Per Type	

Table 19: Default Digital Input Setpoints

3.3. Digital Output Setpoints

The Digital Output setpoints are defined in Section 0. Refer to that section for detailed information on how these setpoints are used. The screen capture below in Figure 7 displays the available setpoints for each of the Digital Outputs. Table 20 below highlights the allowable ranges for each setpoint.

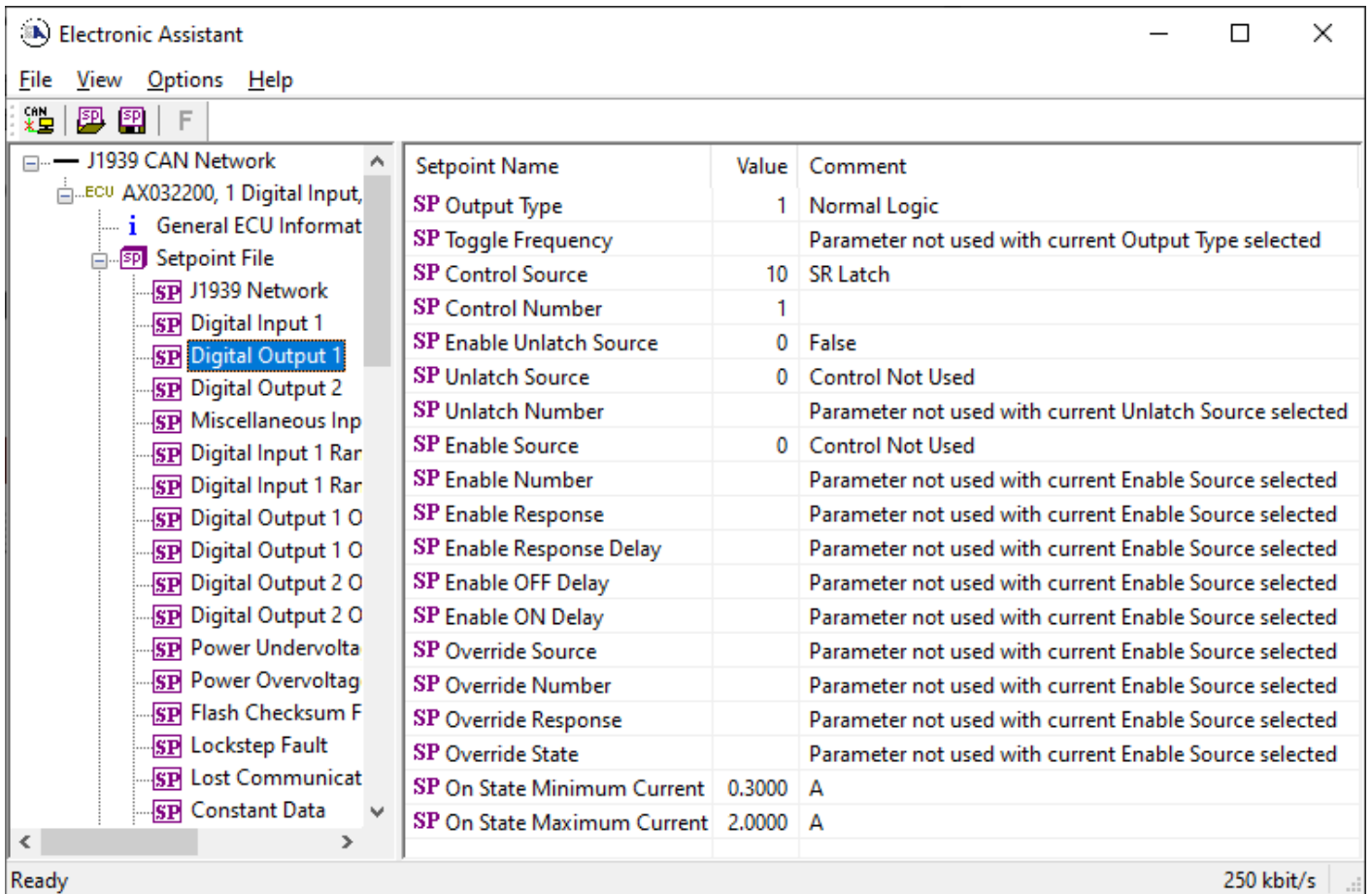

Figure 7: Screen Capture of Default Digital Output Setpoints

Name	Range	Default	Notes
Output Type	Drop List	Normal Logic	Refer to Table 8
Toggle Frequency	0...60,000	0	Units in [milliseconds]
Control Source	Drop List	Digital Input	Refer to Table 1
Control Number	Depends on Source Selected		Refer to Table 1
Unlatch Source	Drop List	Control Not Used	Refer to Table 1
Unlatch Number	Depends on Source Selected	-	Refer to Table 1
Enable Source	Drop List	Control not Used	Refer to Table 1
Enable Number	Depends on Source Selected	-	Refer to Table 1
Enable Response	Drop List	Enable When ON	Refer to Table 7
Enable Response Delay	Drop List	False	
Enable OFF Delay	0...84,600,000	0	
Enable ON Delay	0...84,600,000	0	
Override Source	Drop List	Control not Used	Refer to Table 1
Override Number	Depends on Source Selected	-	Refer to Table 1
Override Response	Drop List	Enable When ON	Refer to Table 5
Override State	Drop List	False	Refer to Table 6
On State Minimum Current	0.0... 5.0	0.3	Units in [Amps]
On State Maximum Current	0.0... 5.0	2.0	Units in [Amps]

Table 20: Default Digital Output Setpoints

3.4. Miscellaneous Setpoints

The Miscellaneous setpoints are defined in Section 0. Refer to that section for detailed information on how these setpoints are used. The screen capture below in Figure 8 **Error! Reference source not found.** displays the available setpoints. Table 21 highlights the allowable ranges for each setpoint.

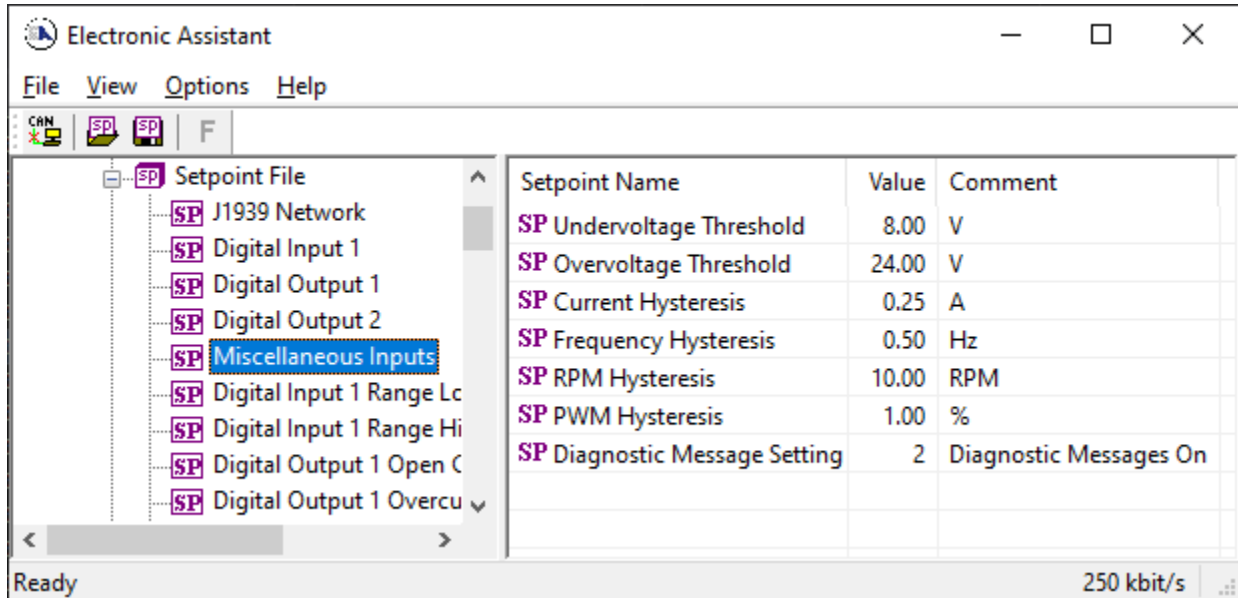

Figure 8: Screen Capture of Default Miscellaneous Setpoints

Name	Range	Default	Notes
Undervoltage Threshold	6.0...36.0	8.0	Units in [Volts]
Overvoltage Threshold	6.0...36.0	24.0	Units in [Volts]
Current Hysteresis	0...5.0	0.25	Units in [Amps]
Frequency Hysteresis	1...10000	0.5	Units in [Hz]
RPM Hysteresis	0...2500	10	Units in [RPM]
PWM Hysteresis	5...95	1	Units in [%]
Diagnostic Message Setting	Drop List	Diagnostics On	

Table 21: Default Miscellaneous Setpoints

3.5. Diagnostic Setpoints

The Diagnostic setpoints are defined in Section 1.6. Refer to that subsection for detailed information on how these setpoints are used. The screen capture below in Figure 9 displays the available setpoints for the Power Supply Diagnostic setpoints. Table 22 below highlights the allowable ranges for each setpoint.

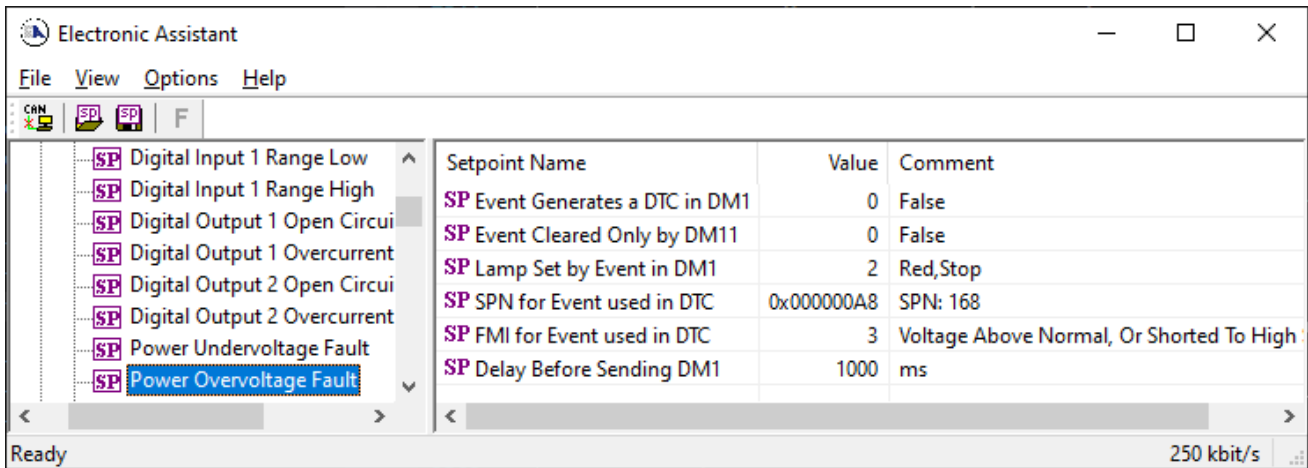

Figure 9: Screen Capture of Default Diagnostic Setpoints

Name	Range	Default	Notes
Event Generates a DTC in DM1	Drop List	False	Refer to Section 1.6
Event Cleared Only by DM11	Drop List	False	Refer to Section 1.6
Lamp Set by Event in DM1	Drop List	Amber, Warning	Refer to Section 1.6
SPN for Event used in DTC	0...524,287	520704	Refer to Section 1.6
FMI for Event used in DTC	Drop List	Voltage Below Normal, Or Shorted to Low Source	Refer to Table 9
Delay Before Sending DM1	0...84,600,000	1000	Units in [milliseconds]
Delay Before Clearing DM1	0...84,600,000	0	If digital output OFF after this time, a DTC will not be sent on a DM1 message anymore.

Table 22: Default Diagnostic Setpoints

3.6. Constant Data List Setpoints

The Constant Data List function block is provided to allow the user to select values as desired for various logic block functions. The function block provides two pre-set (for 0 and 1) and four constant signals. The four constants are fully user configurable to any value between +/- 1,000,000. The default values are displayed in the screen capture below.

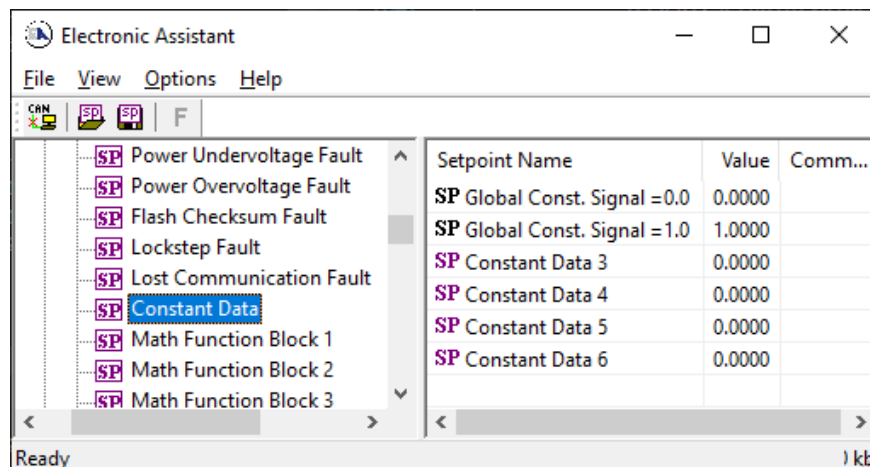

Figure 10: Screen Capture of Constant Data Setpoints

3.7. Math Functional Block Setpoints

The Math Functional Block setpoints are defined in Section 0. Refer to that section for detailed information on how these setpoints are used. The screen capture in Figure 11 displays the available setpoints for each of the Math Blocks. The table below the screen capture highlights the allowable ranges for each setpoint.

Setpoint Name	Value	Comment
SP Math Enabled	0	False
SP Math Output Minimum Range	0.00	
SP Math Output Maximum Range	100.00	
SP Input 1 Source	0	Control Not Used
SP Input 1 Number	1	
SP Input 1 Minimum	0.00	
SP Input 1 Maximum	100.00	
SP Input 1 Gain	0.00	
SP Input 2 Source	0	Control Not Used
SP Input 2 Number	1	
SP Input 2 Minimum	0.00	
SP Input 2 Maximum	100.00	
SP Input 2 Gain	0.00	
SP Input 3 Source	0	Control Not Used
SP Input 3 Number	1	
SP Input 3 Minimum	0.00	
SP Input 3 Maximum	100.00	
SP Input 3 Gain	0.00	
SP Input 4 Source	0	Control Not Used
SP Input 4 Number	1	
SP Input 4 Minimum	0.00	
SP Input 4 Maximum	100.00	
SP Input 4 Gain	0.00	
SP Math Function 1	0	=, True when InA Equals InB
SP Math Function 2	0	=, True when InA Equals InB
SP Math Function 3	0	=, True when InA Equals InB

Figure 11: Screen Capture of Math Functional Block Setpoints

Name	Range	Default	Notes
Math Enabled	Drop List	False	
Math Output Minimum Range	-32768...32767	0	
Math Output Maximum Range	-32768...32767	100.0	
Input 1 Source	Drop List	Control not used	Refer to Table 1
Input 1 Number	Depends on control source	1	Refer to Table 1
Input 1 Minimum	$-10^6 \dots 10^6$	0.00	
Input 1 Maximum	$-10^6 \dots 10^6$	10000.00	
Input 1 Gain	-100...100	100	
Input 2 Source	Drop List	Control not used	Refer to Table 1
Input 2 Number	Depends on control source	1	Refer to Table 1
Input 2 Minimum	$-10^6 \dots 10^6$	0.00	
Input 2 Maximum	$-10^6 \dots 10^6$	10000.00	
Input 2 Gain	-100...100	100	
Input 3 Source	Drop List	Control not used	Refer to Table 1
Input 3 Number	Depends on control source	1	Refer to Table 1
Input 3 Minimum	$-10^6 \dots 10^6$	0.00	
Input 3 Maximum	$-10^6 \dots 10^6$	10000.00	
Input 3 Gain	-100...100	100	
Input 4 Source	Drop List	Control not used	Refer to Table 1
Input 4 Number	Depends on control source	1	Refer to Table 1
Input 4 Minimum	$-10^6 \dots 10^6$	0.00	
Input 4 Maximum	$-10^6 \dots 10^6$	10000.00	
Input 4 Gain	-100...100	100	
Math Function 1	Drop List	=, True When InA Equals InB	See Table 10
Math Function 2	Drop List	=, True When InA Equals InB	See Table 10
Math Function 3	Drop List	=, True When InA Equals InB	See Table 10

Table 23: Default Math Functional Block Setpoints

3.8. Programmable Logic Block Setpoints

The Programmable Logic Block setpoints are defined in Section 0. Refer to that section for detailed information on how these setpoints are used. The screen capture in Figure 12 displays the available setpoints for each of the Programmable Logic Blocks. The table below the screen capture highlights the allowable ranges for each setpoint.

Setpoint Name	Value	Comment
SP Logic Enabled	0	False
SP Table Number 1	1	Lookup Table 1
SP Logical Operator 1	0	Default Table
SP Table 1 - Condition 1 Argument 1 Source	0	
SP Table 1 - Condition 1 Argument 1 Number	1	
SP Table 1 - Condition 1 Argument 2 Source	0	
SP Table 1 - Condition 1 Argument 2 Number	1	
SP Table 1 - Condition 1 Operator	0	=, Equal
SP Table 1 - Condition 2 Argument 1 Source	0	
SP Table 1 - Condition 2 Argument 1 Number	1	
SP Table 1 - Condition 2 Argument 2 Source	0	
SP Table 1 - Condition 2 Argument 2 Number	1	
SP Table 1 - Condition 2 Operator	0	=, Equal
SP Table 1 - Condition 3 Argument 1 Source	0	
SP Table 1 - Condition 3 Argument 1 Number	1	
SP Table 1 - Condition 3 Argument 2 Source	0	
SP Table 1 - Condition 3 Argument 2 Number	1	
SP Table 1 - Condition 3 Operator	0	=, Equal
SP Table Number 2	2	Lookup Table 2
SP Logical Operator 2	0	Default Table
SP Table 2 - Condition 1 Argument 1 Source	0	
SP Table 2 - Condition 1 Argument 1 Number	1	
SP Table 2 - Condition 1 Argument 2 Source	0	
SP Table 2 - Condition 1 Argument 2 Number	1	
SP Table 2 - Condition 1 Operator	0	=, Equal
SP Table 2 - Condition 2 Argument 1 Source	0	

Figure 12: Screen Capture of Programmable Logic Block Setpoints

Name	Range	Default	Notes
Logic Enabled	Drop List	False	
Table Number 1	1 to 12	Lookup Table 1	
Logical Operator 1	Drop List	Default Table	See Table 12
Table 1 - Condition 1 Argument 1 Source	Drop List	Control Not Used	Refer to Table 1
Table 1 - Condition 1 Argument 1 Number	Depends on control source	1	Refer to Table 1
Table 1 - Condition 1 Argument 2 Source	Drop List	Control Not Used	Refer to Table 1
Table 1 - Condition 1 Argument 2 Number	Depends on control source	1	Refer to Table 1
Table 1 - Condition 1 Operator	Drop List	=, Equal	See Table 11
Table 1 - Condition 2 Argument 1 Source	Drop List	Control Not Used	Refer to Table 1
Table 1 - Condition 2 Argument 1 Number	Depends on control source	1	Refer to Table 1
Table 1 - Condition 2 Argument 2 Source	Drop List	Control Not Used	Refer to Table 1
Table 1 - Condition 2 Argument 2 Number	Depends on control source	1	Refer to Table 1
Table 1 - Condition 2 Operator	Drop List	=, Equal	See Table 11
Table 1 - Condition 3 Argument 1 Source	Drop List	Control Not Used	Refer to Table 1
Table 1 - Condition 3 Argument 1 Number	Depends on control source	1	Refer to Table 1
Table 1 - Condition 3 Argument 2 Source	Drop List	Control Not Used	Refer to Table 1
Table 1 - Condition 3 Argument 2 Number	Depends on control source	1	Refer to Table 1
Table 1 - Condition 3 Operator	Drop List	=, Equal	See Table 11

Table 24: Default Programmable Logic Block Setpoints

3.9. Lookup Table Setpoints

The Lookup Table Block setpoints are defined in Section 1.10. Refer to that section for detailed information on how these setpoints are used. The screen capture in Figure 14 displays the available setpoints for each of the Lookup Table Setpoints. The table below the screen capture highlights the allowable ranges for each setpoint.

Setpoint Name	Value	Comment
SP X-Axis Source	0	Control Not Used
SP X-Axis Number	1	
SP X-Axis Type	0	Data Response
SP Auto Repeat	0	False
SP Response 1	0	Ignore
SP Response 2	0	Ignore
SP Response 3	0	Ignore
SP Response 4	0	Ignore
SP Response 5	0	Ignore
SP Response 6	0	Ignore
SP Response 7	0	Ignore
SP Response 8	0	Ignore
SP Response 9	0	Ignore
SP Response 10	0	Ignore
SP Point X1	0.000	
SP Point X2	0.000	
SP Point X3	0.000	
SP Point X4	0.000	
SP Point X5	0.000	
SP Point X6	0.000	
SP Point X7	0.000	
SP Point X8	0.000	
SP Point X9	0.000	
SP Point X10	0.000	
SP Point Y1	0.000	
SP Point Y2	0.000	
SP Point Y3	0.000	
SP Point Y4	0.000	
SP Point Y5	0.000	
SP Point Y6	0.000	
SP Point Y7	0.000	
SP Point Y8	0.000	
SP Point Y9	0.000	
SP Point Y10	0.000	

Figure 13: Screen Capture of Lookup Table Setpoints

Name	Range	Default	Notes
X-Axis Source	Drop List	Control Not Used	Refer to Table 1
X-Axis Number	Depends on control source	1	Refer to Table 1
X-Axis Type	Drop List	Data Response	See Table 13
Auto Repeat	Drop List	False	
X Decimal Digits	0...3	0	Resolution is 10^x , affects X points
Y Decimal Digits	0...3	0	Resolution is 10^x , affects Y points
Response 1	Drop List	Ramp To	See Table 14
Response 2	Drop List	Ramp To	See Table 14
Response 3	Drop List	Ramp To	See Table 14
Response 4	Drop List	Ramp To	See Table 14
Response 5	Drop List	Ramp To	See Table 14
Response 6	Drop List	Ramp To	See Table 14
Response 7	Drop List	Ramp To	See Table 14
Response 8	Drop List	Ramp To	See Table 14
Response 9	Drop List	Ramp To	See Table 14
Response 10	Drop List	Ramp To	See Table 14
Point X1	From X-Axis source minimum to Point 1 - X Value	X-Axis source minimum Depends on the Table number	See Section 1.10
Point X2	From Point 0 - X Value to Point 2 - X Value	Depends on the Table number	See Section 1.10
Point X3	From Point 1 - X Value to Point 3 - X Value	Depends on the Table number	See Section 1.10
Point X4	From Point 2 - X Value to Point 4 - X Value	Depends on the Table number	See Section 1.10
Point X5	From Point 3 - X Value to Point 5 - X Value source	Depends on the Table number	See Section 1.10
Point X6	From Point 4 - X Value to Point 6 - X Value	Depends on the Table number	See Section 1.10
Point X7	From Point 5 - X Value to Point 7 - X Value	Depends on the Table number	See Section 1.10
Point X8	From Point 6 - X Value to Point 8 - X Value	Depends on the Table number	See Section 1.10
Point X9	From Point 7 - X Value to Point 9 - X Value	Depends on the Table number	See Section 1.10
Point X10	From Point 8 - X Value to Point 10 - X Value	Depends on the Table number	See Section 1.10
Point Y1	-10^6 to 10^6	Depends on the Table number	
Point Y2	-10^6 to 10^6	Depends on the Table number	
Point Y3	-10^6 to 10^6	Depends on the Table number	
Point Y4	-10^6 to 10^6	Depends on the Table number	
Point Y5	-10^6 to 10^6	Depends on the Table number	
Point Y6	-10^6 to 10^6	Depends on the Table number	
Point Y7	-10^6 to 10^6	Depends on the Table number	
Point Y8	-10^6 to 10^6	Depends on the Table number	
Point Y9	-10^6 to 10^6	Depends on the Table number	
Point Y10	-10^6 to 10^6	Depends on the Table number	

Table 25: Default Lookup Table Setpoints

3.10. Conditional Block Setpoints

The Conditional Block setpoints are defined in Section 1.11. Refer to that section for detailed information on how these setpoints are used. The screen capture in Figure 14 displays the available setpoints for each of the Conditional Blocks. The table below the screen capture highlights the allowable ranges for each setpoint.

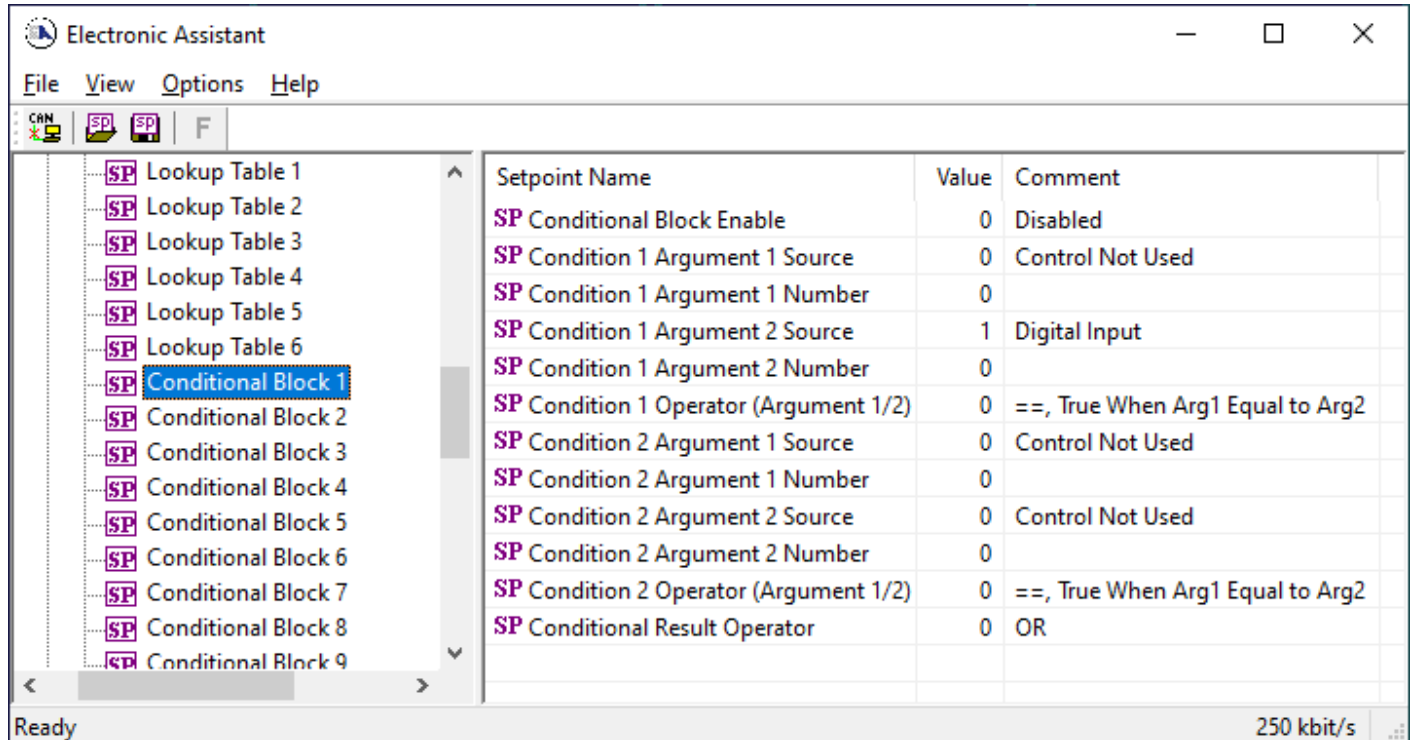

Figure 14: Screen Capture of Conditional Block Setpoints

Name	Range	Default	Notes
Conditional Function Enabled	Drop List	Disabled	
Condition 1 Argument 1 Source	Drop List	Digital Input	Refer to Table 1
Condition 1 Argument 1 Number	Depends on Source Selected	0	Refer to Table 1
Condition 1 Argument 2 Source	Drop List	Digital Input	Refer to Table 1
Condition 1 Argument 2 Number	Depends on Source Selected	0	Refer to Table 1
Condition 1 Operator (Argument 1/2)	Drop List	0	Refer to Table 15
Condition 2 Argument 1 Source	Drop List	Digital Input	Refer to Table 1
Condition 2 Argument 1 Number	Depends on Source Selected	0	Refer to Table 1
Condition 2 Argument 2 Source	Drop List	Digital Input	Refer to Table 1
Condition 2 Argument 2 Number	Depends on Source Selected	0	Refer to Table 1
Condition 2 Operator (Argument 1/2)	Drop List	0	Refer to Table 15
Conditional Result Operator	Drop List	OR	Refer to Table 16

Table 26: Default Conditional Block Setpoints

3.11. Set-Reset Latch Block

The Set-Reset Latch Block setpoints are defined in Section 1.12. Refer to that section for detailed information on how these setpoints are used. The screen capture in Figure 15 displays the available setpoints for each of the Set-Reset Latch Blocks. The table below the screen capture highlights the allowable ranges for each setpoint.

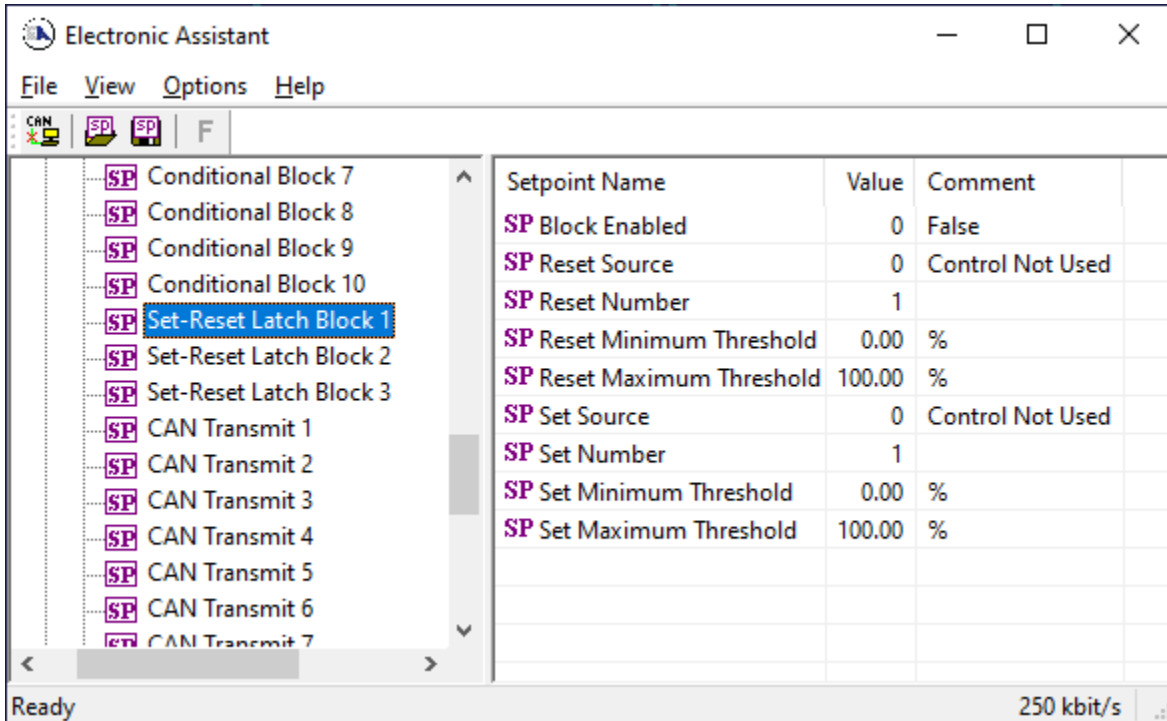

Figure 15: Screen Capture of Set-Reset Latch Block Setpoints

Name	Range	Default	Notes
Block Enabled	Drop List	False	
Reset Source	Drop List	Control Not Used	Refer to Table 1
Reset Number	Depends on Source Selected	1	Refer to Table 1
Reset Minimum Threshold	Drop List	0%	Refer to Section 1.12
Reset Maximum Threshold	Depends on Source Selected	100%	Refer to Section 1.12
Set Source	Drop List	Control Not Used	Refer to Table 1
Set Number	Drop List	1	Refer to Table 1
Set Minimum Threshold	Depends on Source Selected	0%	Refer to Section 1.12
Set Maximum Threshold	Drop List	100%	Refer to Section 1.12

Table 27: Default Set-Reset Latch Block Setpoints

3.12. CAN Transmit Setpoints

The CAN Transmit setpoints are defined in Section 1.13. Refer to that section for detailed information on how these setpoints are used. The screen capture below in Figure 16 displays the available setpoints for the CAN Transmit setpoints. Table 28 below highlights the allowable ranges for the first CAN Transmit setpoint.

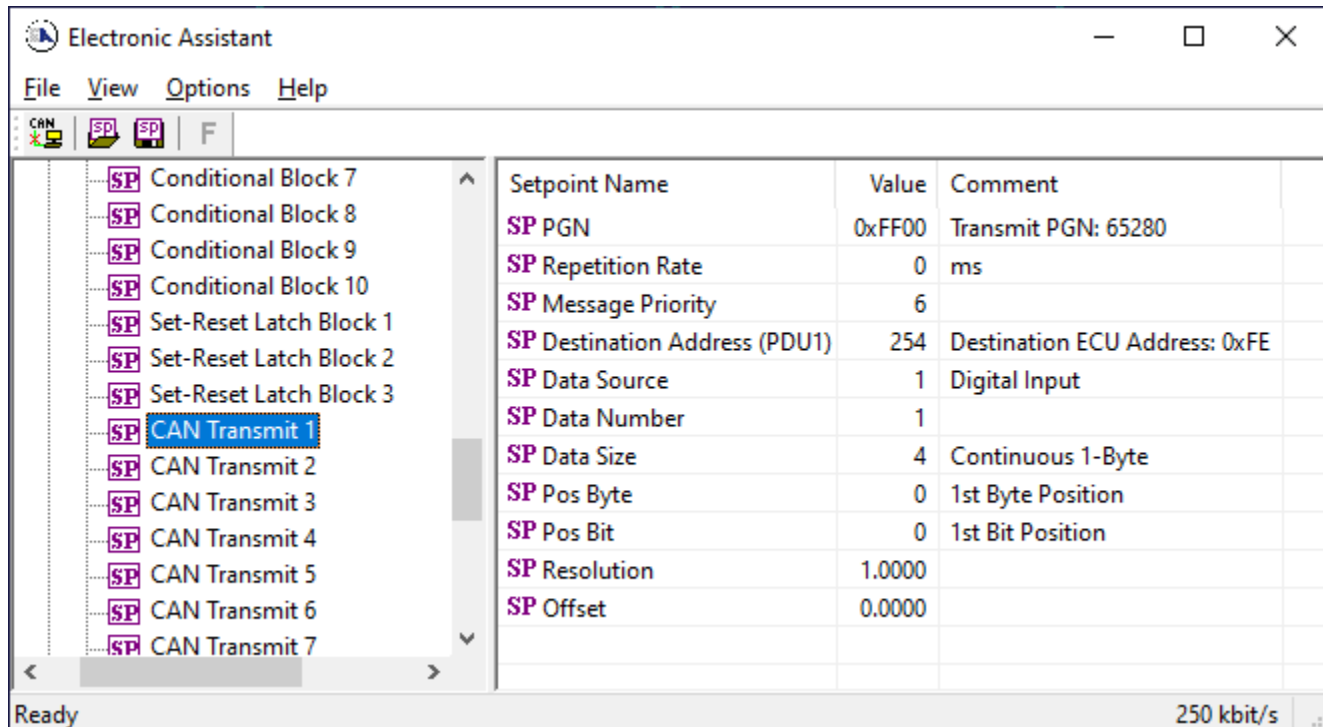

Figure 16: Screen Capture of Default CAN Transmit Setpoints

Name	Range	Default	Notes
PGN	0...65,535	65,280	Refer to Section 1.13
Repetition Rate	0...60,000	1000	Refer to Section 1.13
Message Priority	0...7	6	Refer to Section 1.13
Destination Address (PDU1)	0...255	254	Refer to Section 1.13
Data Source	Drop List		Refer to Table 1
Data Number	Depends on Source Selected	1	Refer to Table 1
Data Size	Drop List	65,280	Refer to Section 1.13
Pos Byte	Depends on Source Selected	0	Refer to Section 1.13
Pos Bit	Depends on Source Selected	65,280	Refer to Section 1.13
Resolution	-100,000...100,000	1	Refer to Section 1.13
Offset	-100,000...100,000	0	Refer to Section 1.13

Table 28: Default CAN Transmit Setpoints

3.13. CAN Receive Setpoints

The CAN Receive setpoints are defined in Section 1.14. Refer to that section for detailed information on how these setpoints are used. The screen capture below in Figure 17 displays the available setpoints for the CAN Receive setpoints. Table 29 below highlights the allowable ranges for each setpoint.

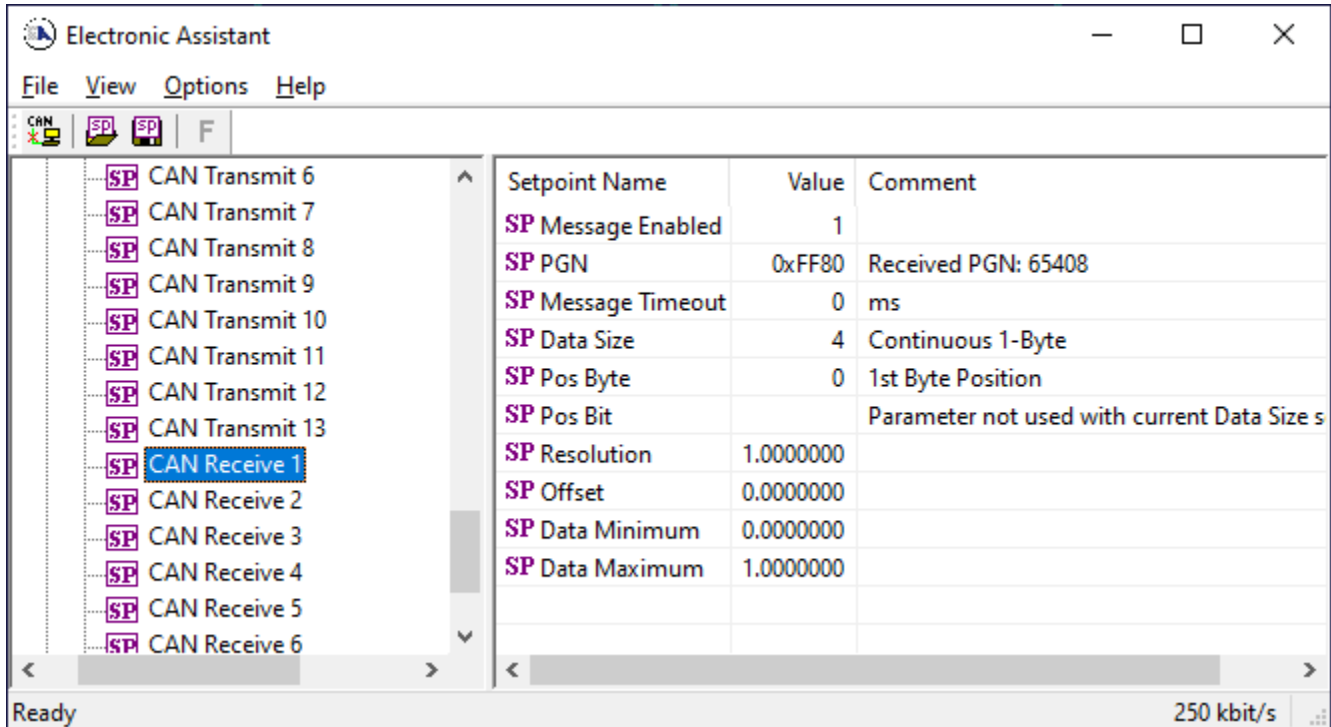

Figure 17: Screen Capture of Default CAN Receive Setpoints

Name	Range	Default	Notes
Message Enabled	Drop List	False	Default changed to <i>True</i> for illustration purposes. Refer to Section 1.14
PGN	0...65,535	65280	Refer to Section 1.14
Message Timeout	0...60,000	3000	Refer to Section 1.14
Data Size	Drop List	Discrete 2-Bit	0 = Not Used (disabled) 1 = Discrete 1-Bit 2 = Discrete 2-Bits 3 = Discrete 4-Bits 4 = 1-Byte Continuous 5 = 2-Bytes Continuous 6 = 4-Bytes Continuous
Pos Byte	0...7	0	Refer to Section 1.14
Pos Bit	0...7	0	Refer to Section 1.14
Resolution	-0xFFFFFFFF...0xFFFFFFFF	1.0	Refer to Section 1.14
Offset	-0xFFFFFFFF...0xFFFFFFFF	0.0	Refer to Section 1.14
Data Minimum	-0xFFFFFFFF...Data Max	0.0	Refer to Section 1.14
Data Maximum	Data Min...0xFFFFFFFF	1.0	Refer to Section 1.14

Table 29: Default CAN Receive Setpoints

4. Re-flashing over CAN with Electronic Assistant Bootloader

This chapter describes a procedure of re-programming an application firmware in CANJ1939 in the field.

4.1. Prerequisites

- A personal computer with a USB port running Windows operating system.
- A flash file for AX032200. It should have the following name: AF-19008-x.xx.bin, where x.xx – firmware version number, and sss are file comments information purposes.
- Axiomatic Electronic Assistant (EA) software, p/n AX070500.
- Axiomatic CAN Assistant – Scope software, p/n AX070501SCO.
- Axiomatic USB-CAN Converter, p/n AX070501. It should be connected to the USB port of the personal computer. (Ordered as AX070502 EA KIT)
- Power supply to power the controllers.
- Wire harness to connect the controllers to the power supply and to the CAN port of the Axiomatic USB-CAN converter with proper termination resistance.

4.2. Re-flashing Procedure

1. Connect the ECU to the power supply and Axiomatic USB-CAN converter.
2. Open CAN port and start monitoring the CAN bus in CAN Assistant – Scope. Make sure that the baud rate is set to 250 kBit/s.
3. Power-up the controller.
4. Run the Electronic Assistant (EA) software and connect to the CAN port. The user should see the following screen:

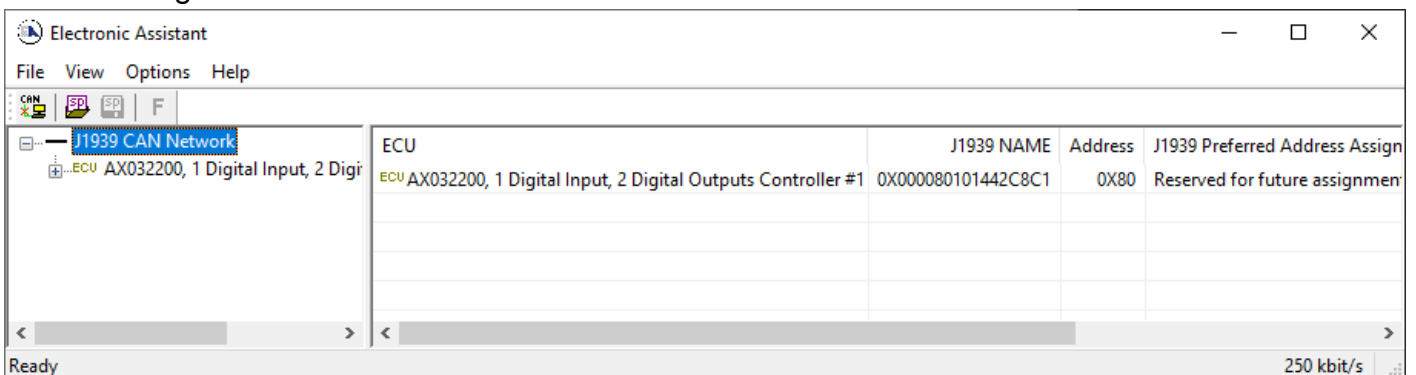

5. Click on *Bootloader Information* group in the left panel and then double click on *Force Bootloader to Load on Reset* and another window pops up. Select *OK* to switch to Bootloader Mode.

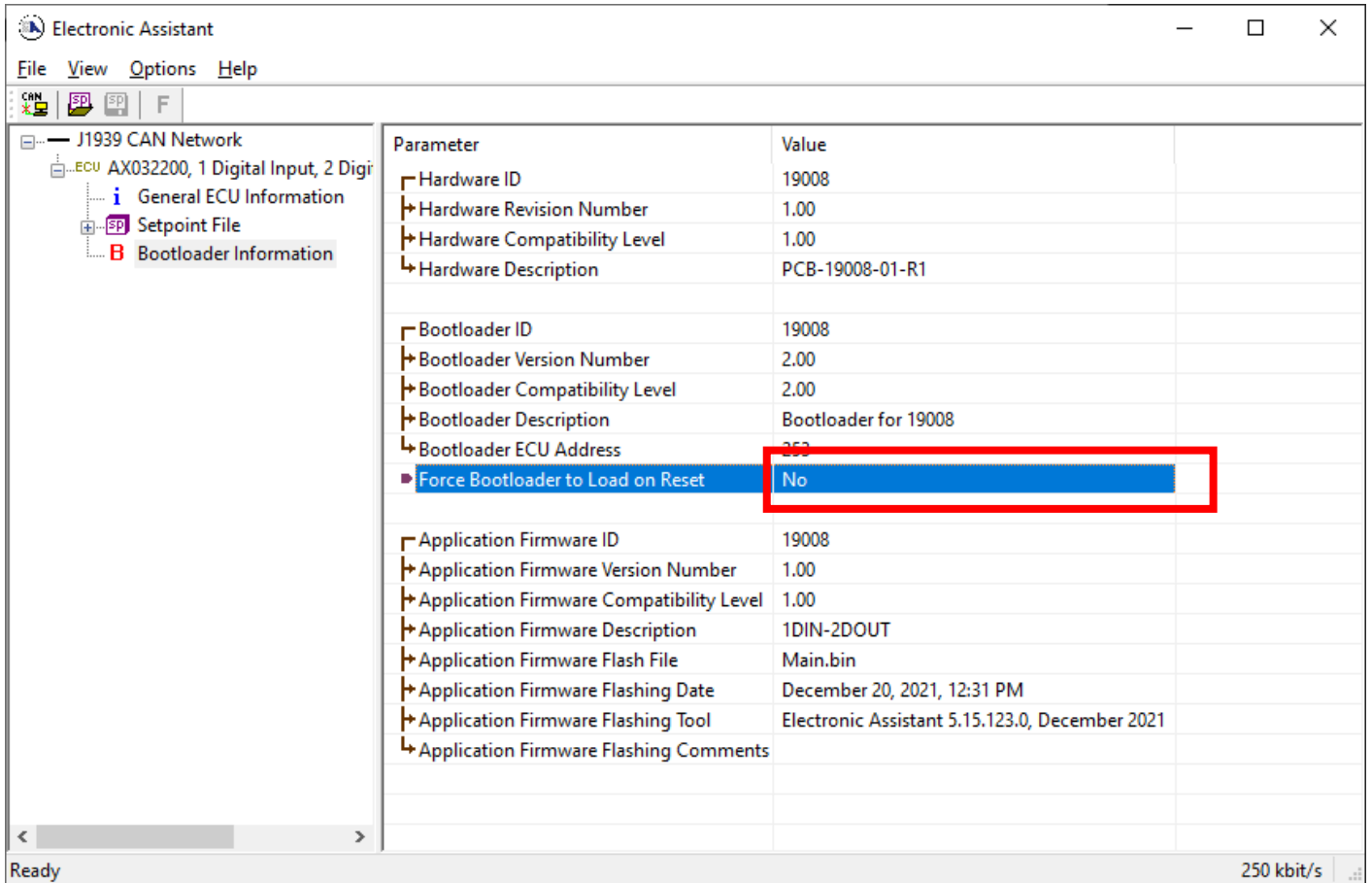

6. Cycle the power on to run the unit in Bootloader Mode. If you disconnect and reconnect the CAN connection in EA, you will only see the Bootloader ECU.

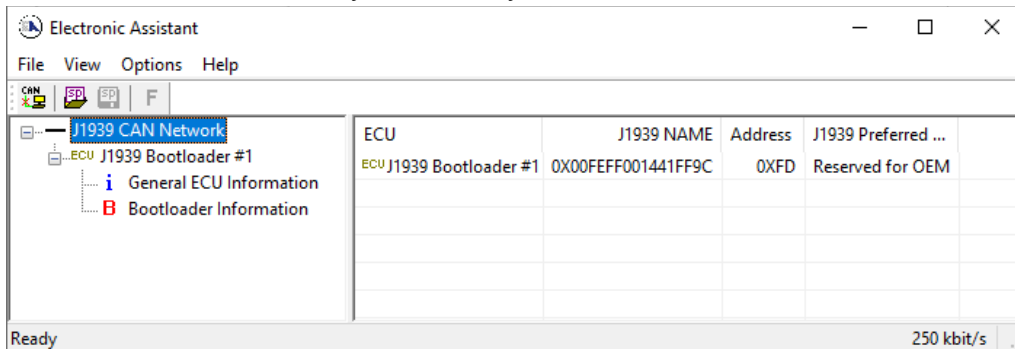

7. Click on the *Bootloader Information* group again and then on the **F** button in the EA toolbar. Select the flash file:

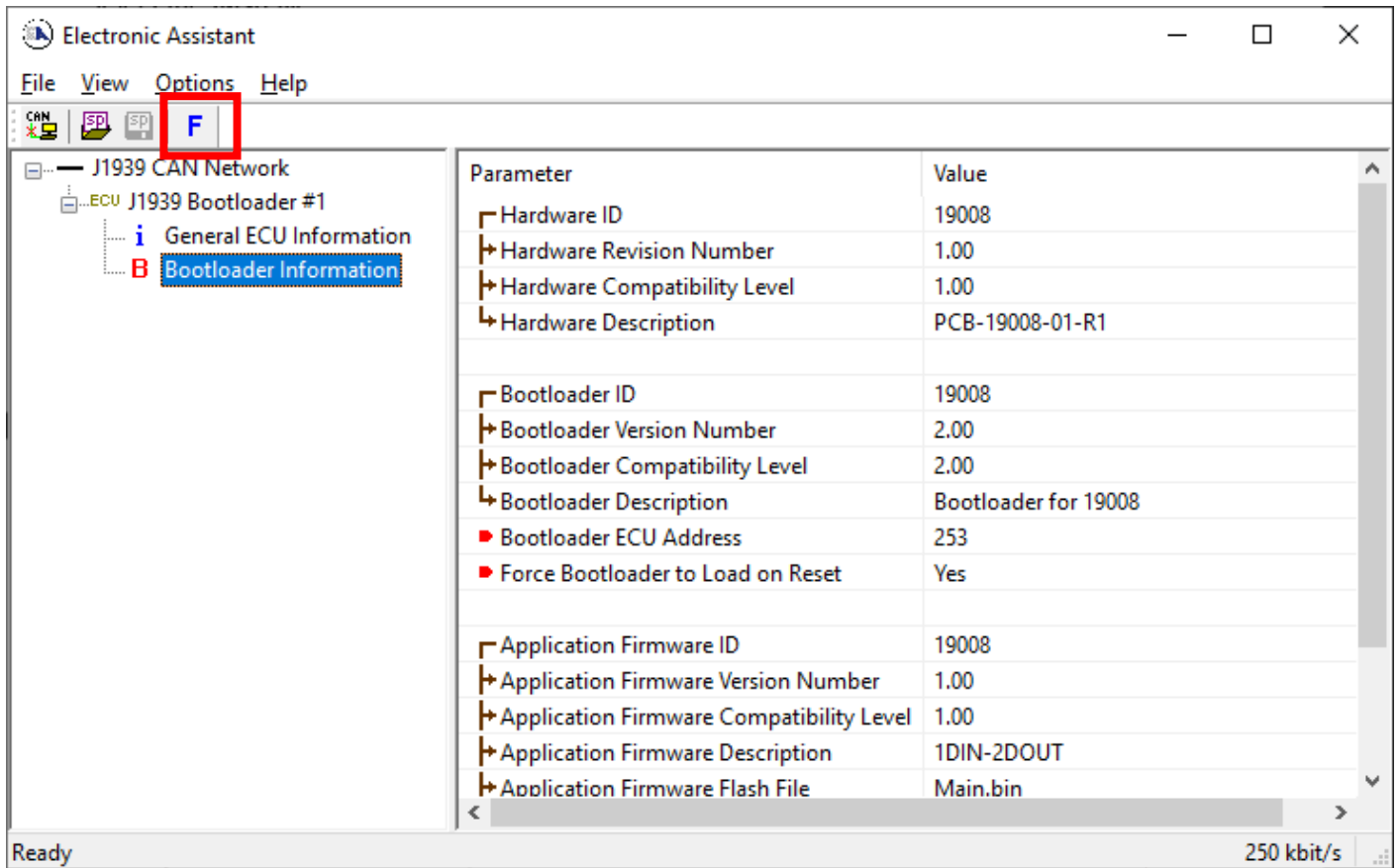

- Open the flash file and start flashing operation by pressing the *Flash ECU* button. **Make sure Erase All ECU Flash Memory is checked.**

Optionally, the user can write their comments in the *Flashing Comments* field.

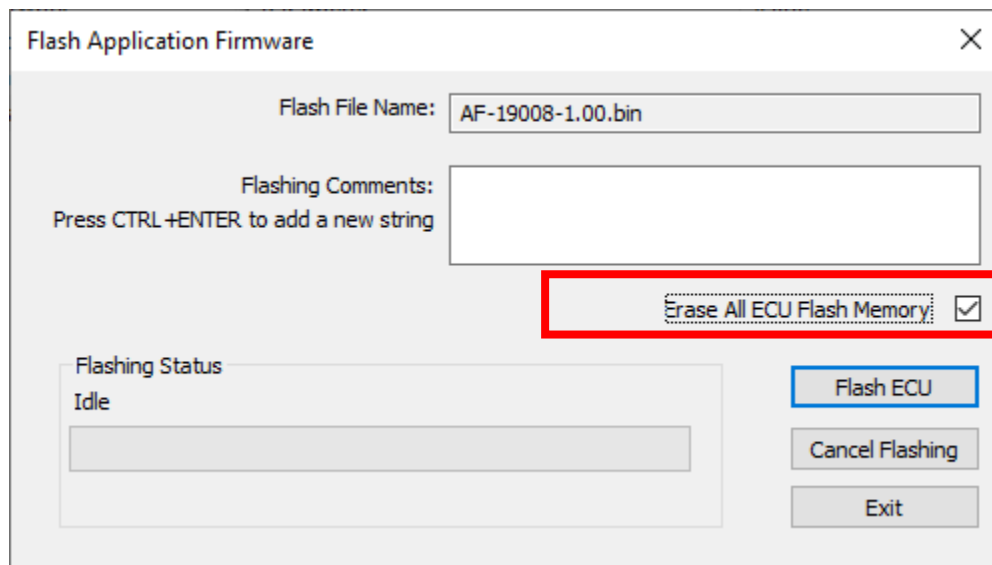

- Confirm the warning message from EA.

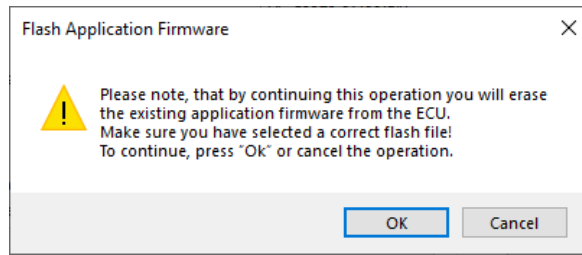

After confirming flashing, the user will see the flashing operation in dynamics on the EA screen.

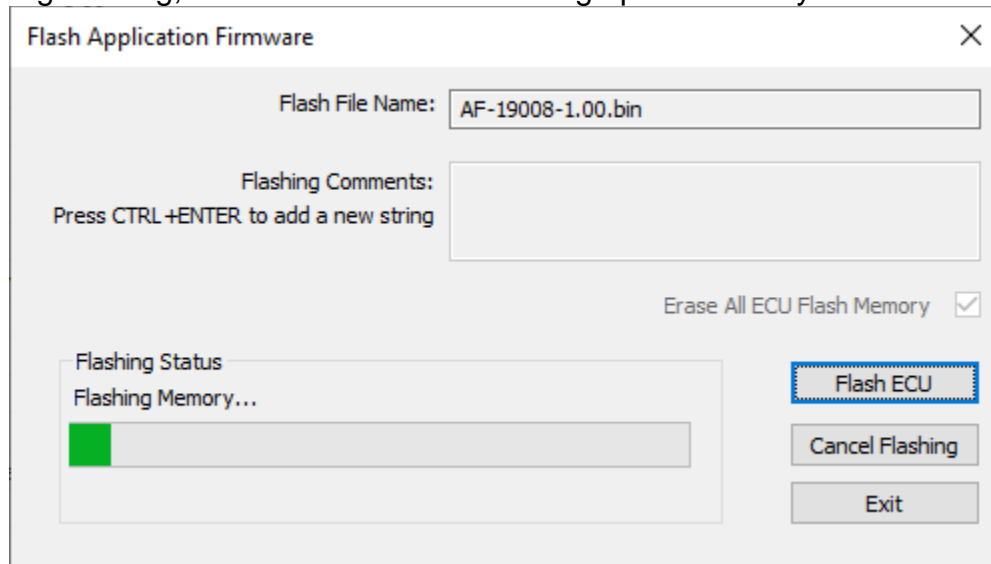

10. When flashing is done, reset the ECU and disconnect and reconnect the CAN connection.

The new firmware version should now be running on the unit, which can be reviewed by selecting Bootloader Information. The user can check the field *Application Firmware Flash File* to make sure that the uploaded firmware version is running on the unit.

Electronic Assistant

File View Options Help

CAN SP SP F

J1939 CAN Network

- ECU AX032200, 1 Digital Input, 2 Digi
 - General ECU Information
 - Setpoint File
 - Bootloader Information**

Parameter	Value
Hardware ID	19008
Hardware Revision Number	1.00
Hardware Compatibility Level	1.00
Hardware Description	PCB-19008-01-R1
Bootloader ID	19008
Bootloader Version Number	2.00
Bootloader Compatibility Level	2.00
Bootloader Description	Bootloader for 19008
Bootloader ECU Address	253
Force Bootloader to Load on Reset	No
Application Firmware ID	19008
Application Firmware Version Number	1.00
Application Firmware Compatibility Level	1.00
Application Firmware Description	1DIN-2DOUT
Application Firmware Flash File	AF-19008-1.00.bin

Ready 250 kbit/s

5. INSTALLATION INSTRUCTIONS

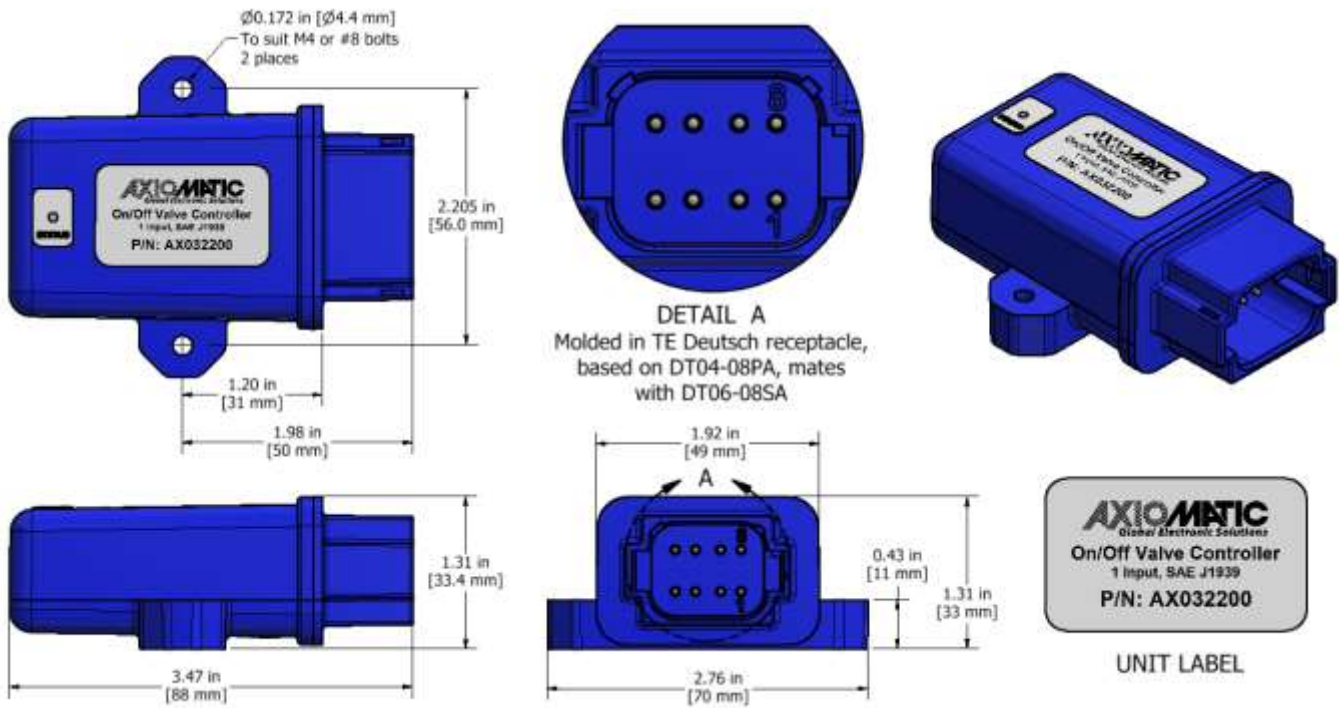

Integral TE Deutsch 8 pin receptacle (P/N: DT04-08PA)
18 AWG wire is recommended.

CAN and I/O Connector	
Pin #	Description
1	CAN_H
2	CAN_L
3	Output GND
4	Input
5	Output 1
6	BATT +
7	BATT -
8	Output 2

6. TECHNICAL SPECIFICATIONS

Specifications are indicative and subject to change. Actual performance will vary depending on the application and operating conditions. Users should satisfy themselves that the product is suitable for use in the intended application. All our products carry a limited warranty against defects in material and workmanship. Please refer to our Warranty, Application Approvals/Limitations and Return Materials Process as described <https://www.axiomatic.com/service/>.

Power

Power Supply Input - Nominal	12 V or 24 Vdc nominal; 8...36 Vdc The minimum allowable supply voltage for the power pin is 7 Vdc.
Surge Protection	Meets the surge requirements of SAE J1445
Reverse Polarity Protection	Provided up to 60V
Undervoltage Protection	Provided at 5V
Overvoltage Protection	Provided at 38V

Input

Input	1 ignition signal input 0 to +Vps Optional input configuration as one digital input with 10K pull-up or pull-down 0 to +Vps amplitude
-------	--

Outputs

Digital Outputs	2 digital outputs (up to 4A sourcing) High Side Current sensing, grounded load Overcurrent protected against shorts to GND or +Supply Digital On/Off: sourcing from power supply or off Load at supply voltage must not draw more than 4A.
-----------------	---

Control Software

Software Platform	Pre-programmed with standard logic.
-------------------	-------------------------------------

General Specifications

Memory	TMS570LS0714; 32-bit, 1024 Kbytes Flash Program Memory
CAN Port	1 CAN (SAE J1939)
Quiescent Current Draw	122.50 mA @ 12Vdc; 71.80 mA @ 24Vdc Typical
Operating Conditions	-40 to 125°C (-40 to 257°F)
Weight	0.15 lb. (0.068 kg) preliminary
Protection Rating	IP67
Vibration	MIL-STD-202G, Test 204D and 214A (Sine and Random) 10 g peak (Sine); 7.86 Grms peak (Random)
Shock	MIL-STD-202G, Test 213B, 50 g
Enclosure and Dimensions	Molded Enclosure, integral connector Nylon 6/6, 30% glass Ultrasonically welded 3.47 x 2.75 x 1.31 inches (88.2 x 70.0 x 33.3 mm) L x W x H including integral connector Refer to Installation Instructions.
Electrical Connections	Integral TE Deutsch 8 pin receptacle (P/N: DT04-08PA) 18 AWG wire is recommended. For pinout, refer to Installation Instructions.
Mating Plug Kit	A mating plug kit is available. Ordering P/N: AX070112 is comprised of 1 DT06-08SA, 1 W8S, 8 0462-201-16141, and 3 114017.
User Interface, Reflashing	Axiomatic Electronic Assistant AX070502

Notes:

CANopen® is a registered community trademark of CAN in Automation e.V.

VERSION HISTORY

Version	Date	Author	Modifications
1.00	December, 2021	Viktor Rogachov	Initial Document
-	March 28, 2022	Amanda Wilkins	Marketing Review

OUR PRODUCTS

AC/DC Power Supplies
Actuator Controls/Interfaces
Automotive Ethernet Converters
Battery Chargers
CAN Controls, Routers, Repeaters
CAN/WiFi, CAN/Bluetooth, Routers
Current/Voltage Converters
DC/DC Power Converters
Engine Temperature Scanners
Ethernet/CAN Converters,
Gateways, Switches
Fan Drive Controllers
Gateways, CAN/Modbus Protocols
Gyroscope Inclinometers
Hydraulic Valve Controllers
Inclinometers, Triaxial
I/O Controls
LVDT Signal Converters
Machine Controls
Modbus Controls
Motor Controls
Power Supplies, DC/DC, AC/DC
PWM Signal Converters/Isolators
Resolver Signal Conditioners
Service Tools
Signal Conditioners, Converters
Strain Gauge CAN Controls
Surge Suppressors

OUR COMPANY

Axiomatic provides electronic machine control components to the off-highway, commercial vehicle, electric vehicle, power generator set, material handling, renewable energy and industrial OEM markets. ***We innovate with engineered and off-the-shelf machine controls that add value for our customers.***

QUALITY DESIGN AND MANUFACTURING

We have an ISO9001:2015 registered design/manufacturing facility in Canada.

WARRANTY, APPLICATION APPROVALS/LIMITATIONS

Axiomatic Technologies Corporation reserves the right to make corrections, modifications, enhancements, improvements, and other changes to its products and services at any time and to discontinue any product or service without notice. Customers should obtain the latest relevant information before placing orders and should verify that such information is current and complete. Users should satisfy themselves that the product is suitable for use in the intended application. All our products carry a limited warranty against defects in material and workmanship. Please refer to our Warranty, Application Approvals/Limitations and Return Materials Process at <https://www.axiomatic.com/service/>.

COMPLIANCE

Product compliance details can be found in the product literature and/or on axiomatic.com. Any inquiries should be sent to sales@axiomatic.com.

SAFE USE

All products should be serviced by Axiomatic. Do not open the product and perform the service yourself.



This product can expose you to chemicals which are known in the State of California, USA to cause cancer and reproductive harm. For more information go to www.P65Warnings.ca.gov.

SERVICE

All products to be returned to Axiomatic require a Return Materials Authorization Number (RMA#) from sales@axiomatic.com. Please provide the following information when requesting an RMA number:

- Serial number, part number
- Hours of operation, description of problem
- Wiring set up diagram, application and other comments as needed

DISPOSAL

Axiomatic products are electronic waste. Please follow your local environmental waste and recycling laws, regulations and policies for safe disposal or recycling of electronic waste.

CONTACTS

Axiomatic Technologies Corporation
5915 Wallace Street
Mississauga, ON
CANADA L4Z 1Z8
TEL: +1 905 602 9270
FAX: +1 905 602 9279
www.axiomatic.com
sales@axiomatic.com

Axiomatic Technologies Oy
Höytämöntie 6
33880 Lempäälä
FINLAND
TEL: +358 103 375 750
FAX: +358 3 3595 660
www.axiomatic.com
salesfinland@axiomatic.com