

Automotive Ethernet to Ethernet Converter

USER MANUAL

P/N: AX141520

TABLE OF CONTENT

1. GENERAL INFORMATION	3
1.1 Introduction	3
1.2 Functional Block Diagram of the Converter	3
2. CONNECTORS	4
2.1 M12 8-pin	4
2.2 M12 12-pin	4
3. CONFIGURATION USING RS-232	5
3.1 Show Configuration Parameter	8
3.2 Change Configuration Parameters	9
3.3 Set Default Configuration Parameters	10
3.4 Erase EEPROM	10
3.5 Temperature of Ethernet PHYs	10
3.6 Start/Stop Logs	11
3.7 Reboot the Controller	11
3.8 Activate bootloader	11
3.8.1 Load New Application Firmware	12
4. TECHNICAL SPECIFICATIONS	14
4.1 Power Supply Input	14
4.2 Automotive Ethernet	14
4.3 Ethernet	14
4.4 Interfaces	15
4.5 General Specifications	15
4.6 Housing	16
4.7 Electrical Connectors	17
5. VERSION HISTORY	19

1. GENERAL INFORMATION

1.1 Introduction

The Ethernet to Automotive Ethernet Gigabit Converter, AX141520, has both Ethernet and Automotive Ethernet Physical Layer transceivers (1000BASE-T and 1000BASE-T1 PHYs) that are used to achieve bi-directional communication. The converter supports configuration via RS232 to update the speed (100/1000Mbps) as well as to set the Automotive Ethernet PHY to Master/Slave mode. The AX141520 does not store any packets and does not modify or filter any packets.

By default, both PHYs (Ethernet and the Automotive Ethernet) communicate at a speed of 1000Mbps, and the Automotive Ethernet is configured to work in Slave mode. Status LEDs provide information on *Power*, *Connection Link*, and *Activity*.

Power LED will be ON as soon as power is supplied to the converter. The *Power* LED is used to verify whether power is supplied to the converter. If the proper power supply level is connected to the converter, the *Power* LED will be ON; indicating the converter is ON. The AX141520 is continuously monitoring the status of Link and Activity by reading the registers of Ethernet PHYs and will show the real-time update of Ethernet and Automotive Ethernet Link and Activity on *Link* and *Activity* LEDs, respectively.

1.2 Functional Block Diagram of the Converter

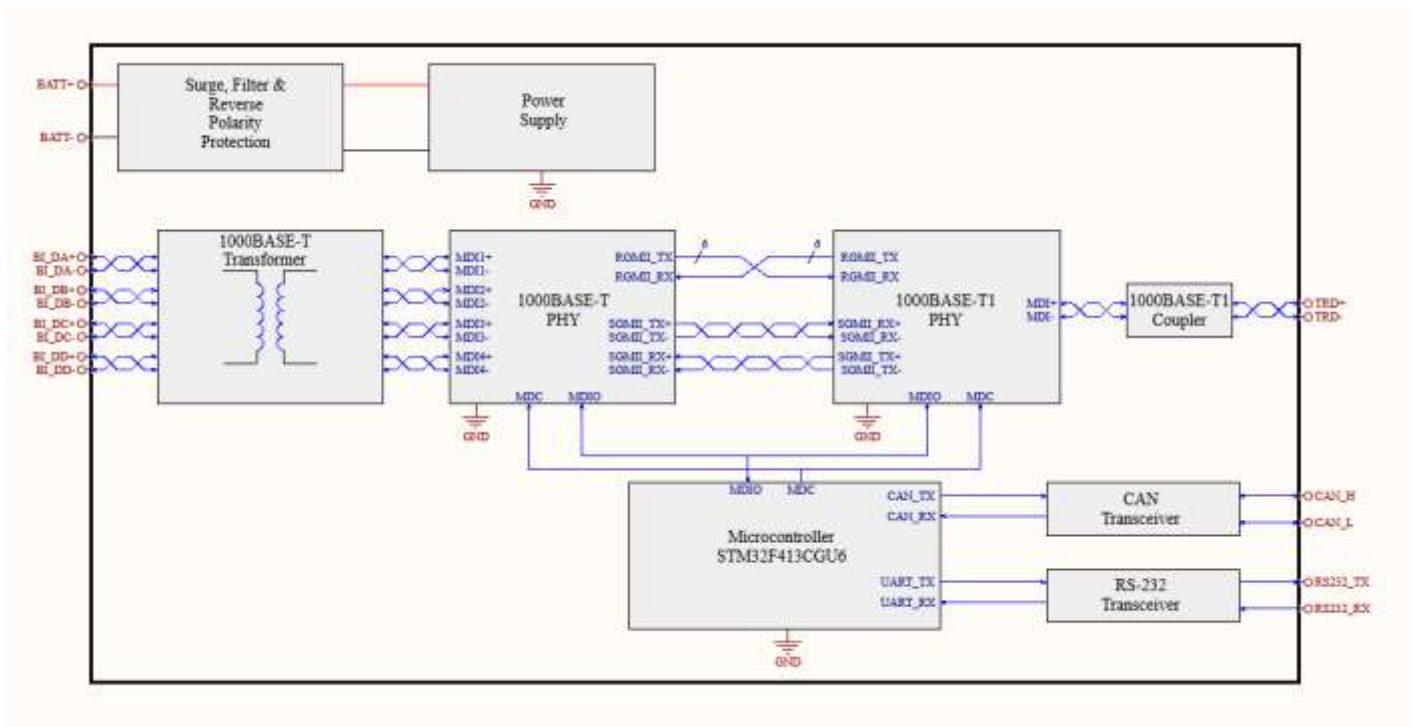

Figure 1 Functional Block Diagram

2. CONNECTORS

The converter has two connectors.

2.1 M12 8-pin

The M12 8-pin connector is used for the Ethernet 1000BASE-T connection. The mating harness P/N is: AX070535.



Figure 2 M12 8-pin Ethernet Connector with RJ45

2.2 M12 12-pin

The M12 12-pin connector is used for power supply, RS-232, CAN, and Automotive Ethernet. 1 Phoenix Contact M12 12-pin connector (A-coded). The mating harness PN is: AX070533

Table 1 M12 12-pin connector

PIN#	Description
1	BATT-
2	BATT-
3	TRD_P
4	TRD_N
5	Not Used
6	RS-232_GND
7	RS-232 TX
8	RS-232 RX
9	BATT+
10	BATT+
11	CAN_L
12	CAN_H

3. CONFIGURATION USING RS-232

RS-232 configuration is password-protected and can be accessed through Tera Term or other serial terminals. Tera Term Serial Port setup is shown below.

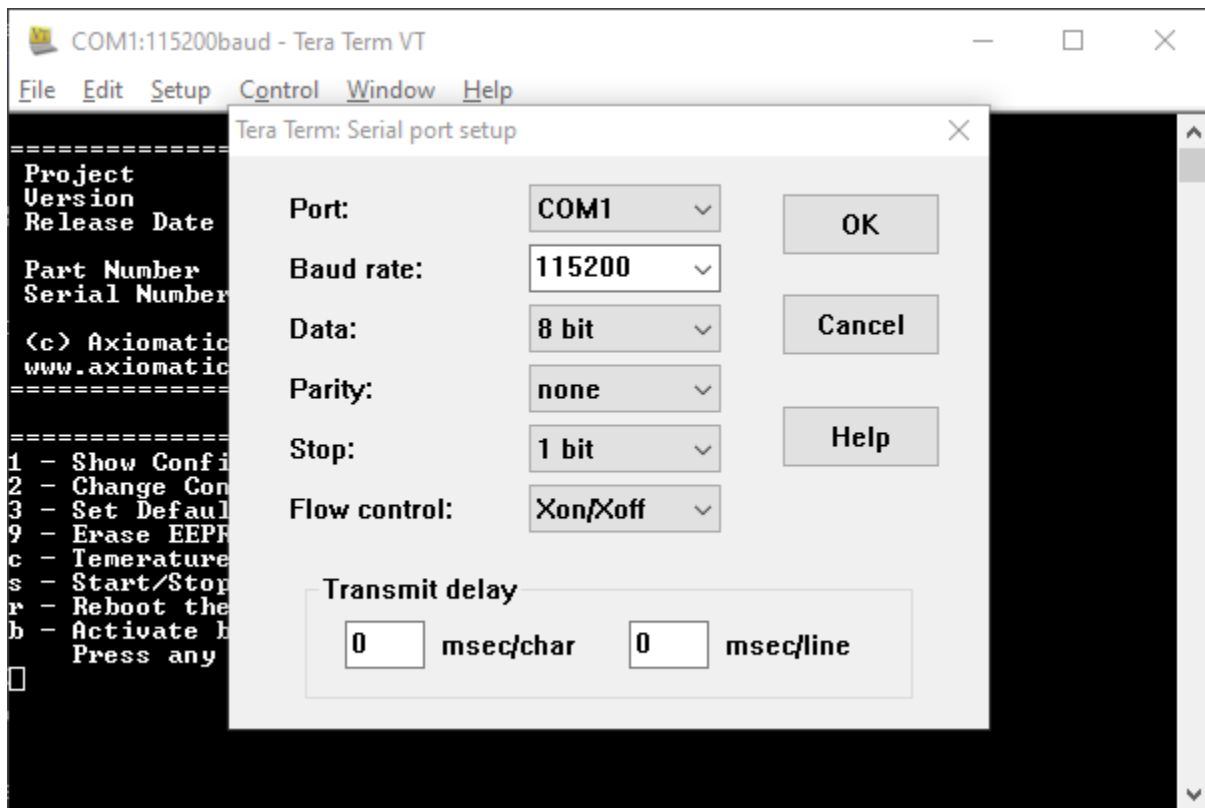
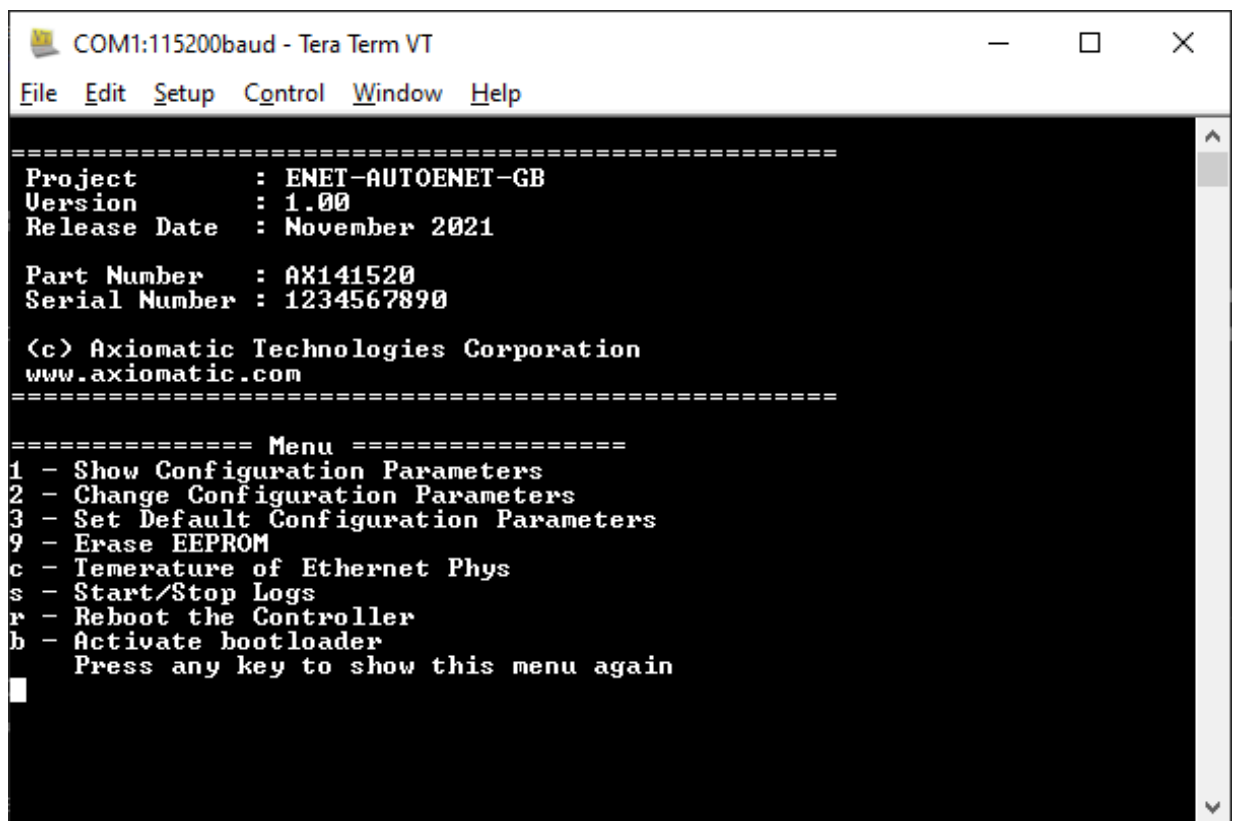

Figure 3 Tera Term: Serial port setup

Default configuration menu includes Project details like Project Name, Version number, Release Date, Part Number, and Serial Number. The menu has 8 options as attached in the picture below. To access any of the 8 options the one-time password is "AX141520".



The image shows a screenshot of a Tera Term VT terminal window. The window title is "COM1:115200baud - Tera Term VT". The menu bar includes "File", "Edit", "Setup", "Control", "Window", and "Help". The terminal content is as follows:

```
=====
Project       : ENET-AUTOENET-GB
Version      : 1.00
Release Date  : November 2021

Part Number   : AX141520
Serial Number : 1234567890

(c) Axiomatic Technologies Corporation
www.axiomatic.com
=====

===== Menu =====
1 - Show Configuration Parameters
2 - Change Configuration Parameters
3 - Set Default Configuration Parameters
9 - Erase EEPROM
c - Temperature of Ethernet Phys
s - Start/Stop Logs
r - Reboot the Controller
b - Activate bootloader
   Press any key to show this menu again
```

Figure 4 Default Tera Term Menu

To view or change the configuration, please enter the password: "AX141520".

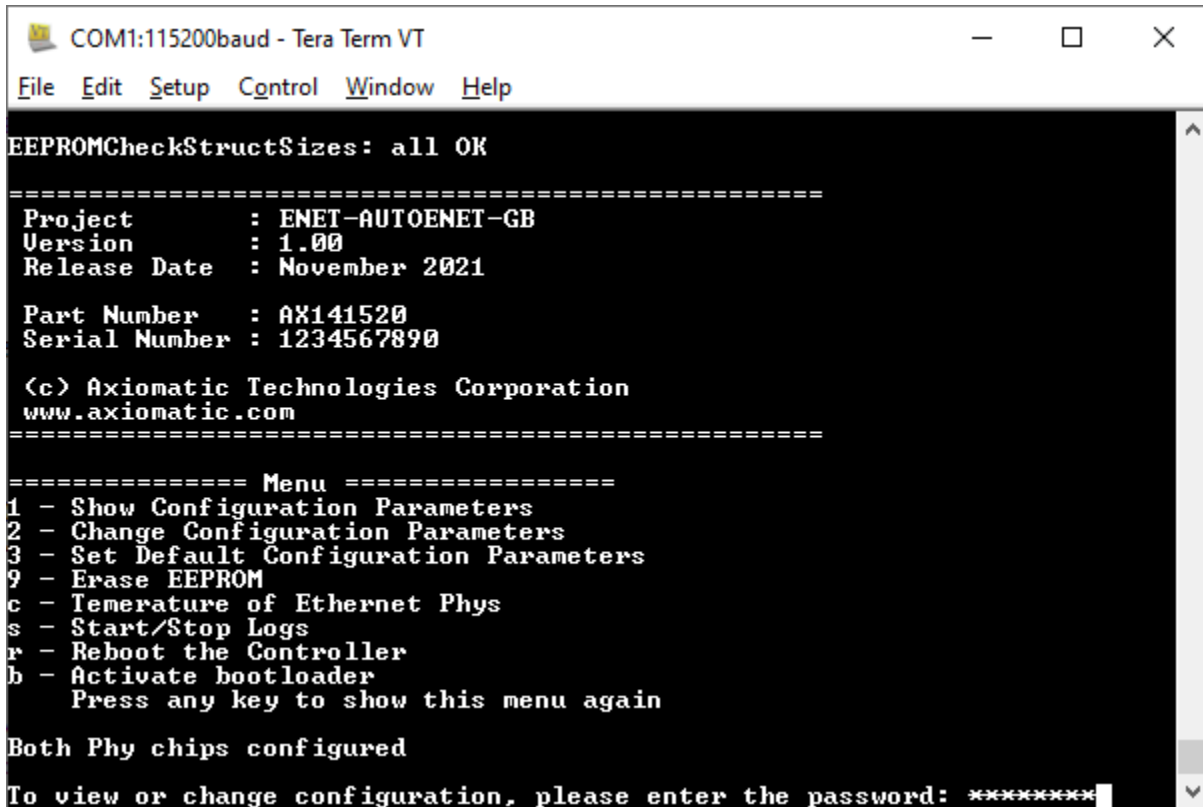

```
COM1:115200baud - Tera Term VT
File Edit Setup Control Window Help
EEPROMCheckStructSizes: all OK
=====
Project      : ENET-AUTOENET-GB
Version     : 1.00
Release Date : November 2021

Part Number  : AX141520
Serial Number: 1234567890

(c) Axiomatic Technologies Corporation
www.axiomatic.com
=====

===== Menu =====
1 - Show Configuration Parameters
2 - Change Configuration Parameters
3 - Set Default Configuration Parameters
9 - Erase EEPROM
c - Temperature of Ethernet Phys
s - Start/Stop Logs
r - Reboot the Controller
b - Activate bootloader
   Press any key to show this menu again

Both Phy chips configured
To view or change configuration, please enter the password: *****
```

Figure 5 One-time password to access the Menu

3.1 Show Configuration Parameter

Press '1' to see the Configuration parameters. This option will show Serial Number, Converter Mode, Converter Speed, and Log Timing.

If the converter Mode is "Master", it shows that Automotive Ethernet PHY is configured to work as Master. If the converter Mode is "Slave", it shows that Automotive Ethernet PHY is configured to work as Slave. Speed shows the speed of both PHYs.

Log Timing is used to see the Power and (Ethernet and Automotive Ethernet) Link logs over RS-232. Logs are used for debugging and testing purposes. Log Timing does not affect the Converter's working and Master-Slave or Speed configuration of PHYs.

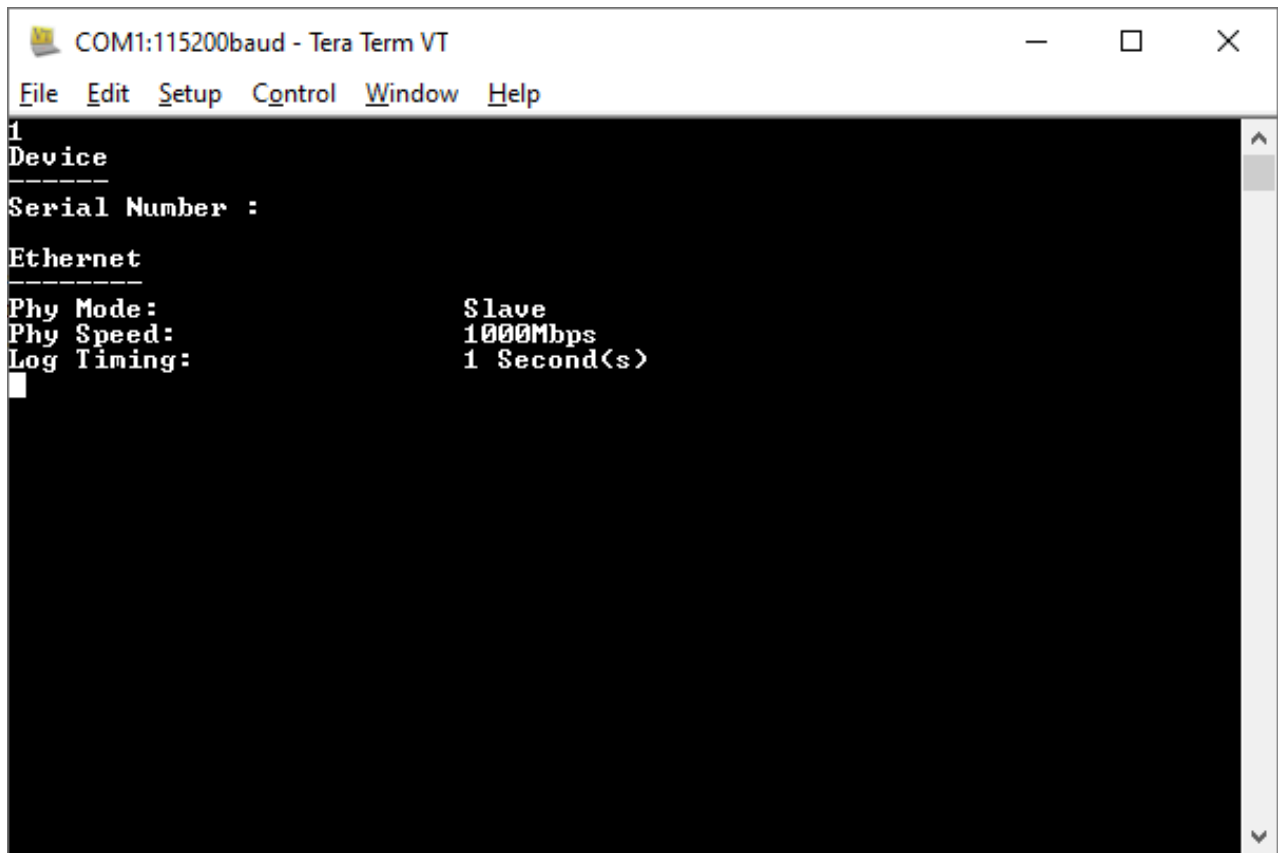

Figure 6 Show Configuration Parameter

3.2 Change Configuration Parameters

Press '2' to change the configuration parameters. This option gives the choice to change Serial Number, Mode, Speed, and Log Timing. Enter the name of the parameter that needs to be changed other than Serial Number. The option to change the Serial Number is not available for field updates.

Enter the name from the list given on the Tera term window. i.e., "Mode", "Speed", or "LogTiming". Any string entered other than given on the Tera Term window will be discarded by the Converter, as the string is case sensitive. i.e., to change Speed, typing "speed" will have no effect as the converter is expecting for the string "Speed". Changing the Speed will change the Speed of both Ethernet and Automotive Ethernet PHYs.

Type "Mode" to change the mode. Press '1' to configure the Automotive Ethernet PHY in Slave mode or '2' for Master mode. Changing the Mode will change the Mode of Automotive Ethernet PHY only, as normal Ethernet PHY has Auto-negotiation enabled to negotiate the Mode.

Log Timing could be configured to have a value between 1 Second to 10 Seconds.

The Master/Slave and Speed settings will be saved. So, after reset or power cycle, the converter will have the last configured Speed, Mode, and Log Timing.

Enter the name of the parameter: "Enter string Mode to change Mode". To change the Speed or Log Timing Follow the same method. As shown in the picture below.

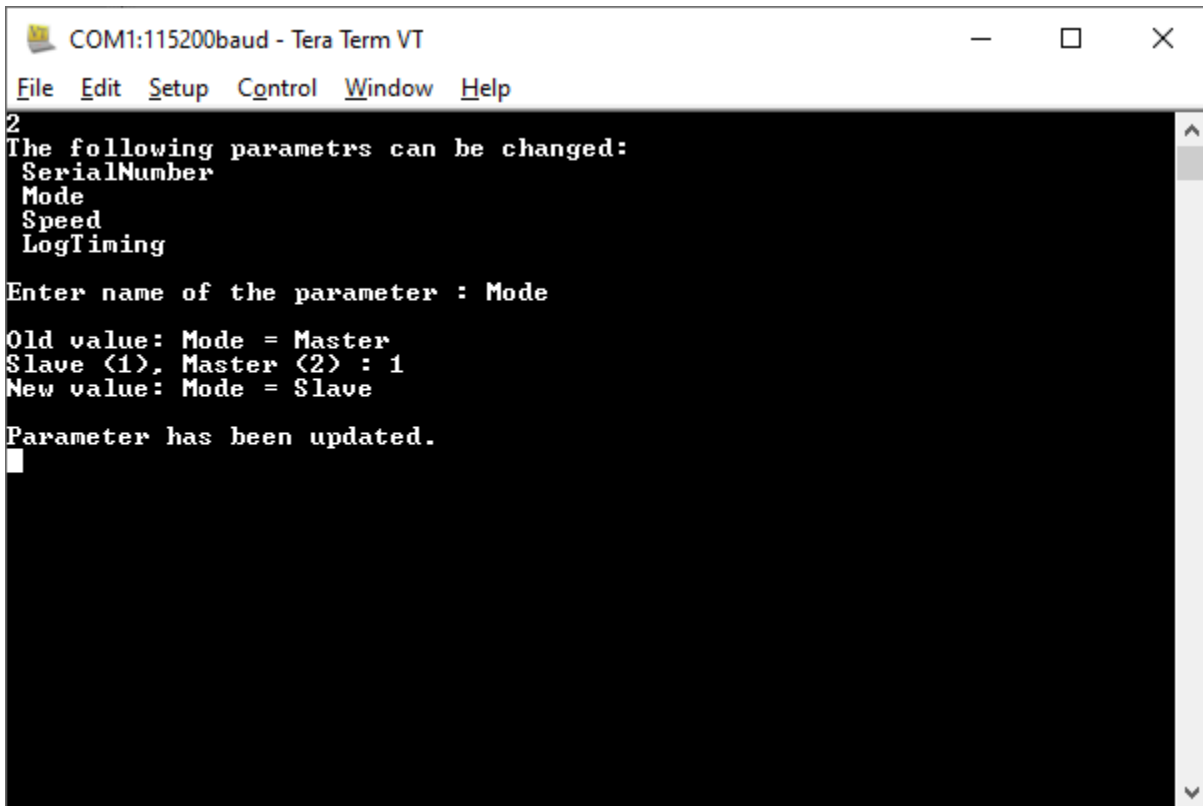

```
COM1:115200baud - Tera Term VT
File Edit Setup Control Window Help
2
The following parametrs can be changed:
SerialNumber
Mode
Speed
LogTiming
Enter name of the parameter : Mode
Old value: Mode = Master
Slave <1>, Master <2> : 1
New value: Mode = Slave
Parameter has been updated.
█
```

Figure 7 Change Parameters "Master to Slave"

3.3 Set Default Configuration Parameters

Press '3' to set the default configuration parameters. This option will set the Mode and Speed to Slave and 1000Mbps respectively, as the default mode is Slave mode and default speed is 1000 Mbps.

The log timing will be also changed to the default value, which is 1 Second.

The configuration settings will be saved. So, after reset or power cycle, the converter will have the last configured Speed, Mode, and Log Timing.

3.4 Erase EEPROM

Press '9' to Erase EEPROM. Erasing the EEPROM will erase the Firmware Flags and Firmware Configurations (Mode/Slave and Log Timing) stored in EEPROM. So, in the next power cycle, the firmware will store default Configuration parameters and Firmware Flags.

This is useful while doing the Firmware Version update, to erase the old version number stored in EEPROM and save the new version number.

3.5 Temperature of Ethernet PHYs

Press 'c'.to read the internal temperature of both the PHYs in Celsius.

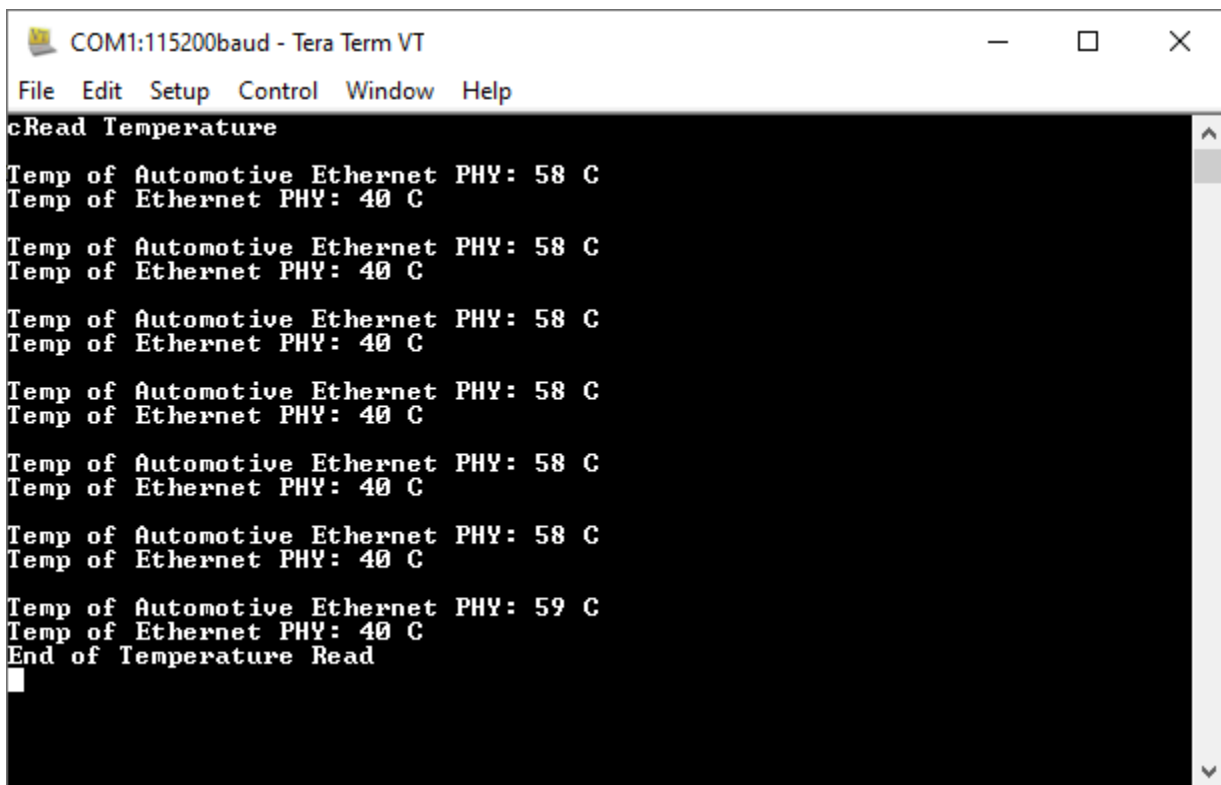

```
COM1:115200baud - Tera Term VT
File Edit Setup Control Window Help
cRead Temperature
Temp of Automotive Ethernet PHY: 58 C
Temp of Ethernet PHY: 40 C
Temp of Automotive Ethernet PHY: 58 C
Temp of Ethernet PHY: 40 C
Temp of Automotive Ethernet PHY: 58 C
Temp of Ethernet PHY: 40 C
Temp of Automotive Ethernet PHY: 58 C
Temp of Ethernet PHY: 40 C
Temp of Automotive Ethernet PHY: 58 C
Temp of Ethernet PHY: 40 C
Temp of Automotive Ethernet PHY: 59 C
Temp of Ethernet PHY: 40 C
End of Temperature Read
```

Figure 8 Temperature of PHYs in Fahrenheit

3.6 Start/Stop Logs

Press 's' to start or stop the debug logs. Starting the debug logs will print the supplied voltage to the Unit and Ethernet and Automotive Ethernet Link status on Tera Term, as per the Log Timing configuration. i.e., If Log Timing is 1 Second, the converter will print the debug logs every second. Pressing 's' again will stop the logs.

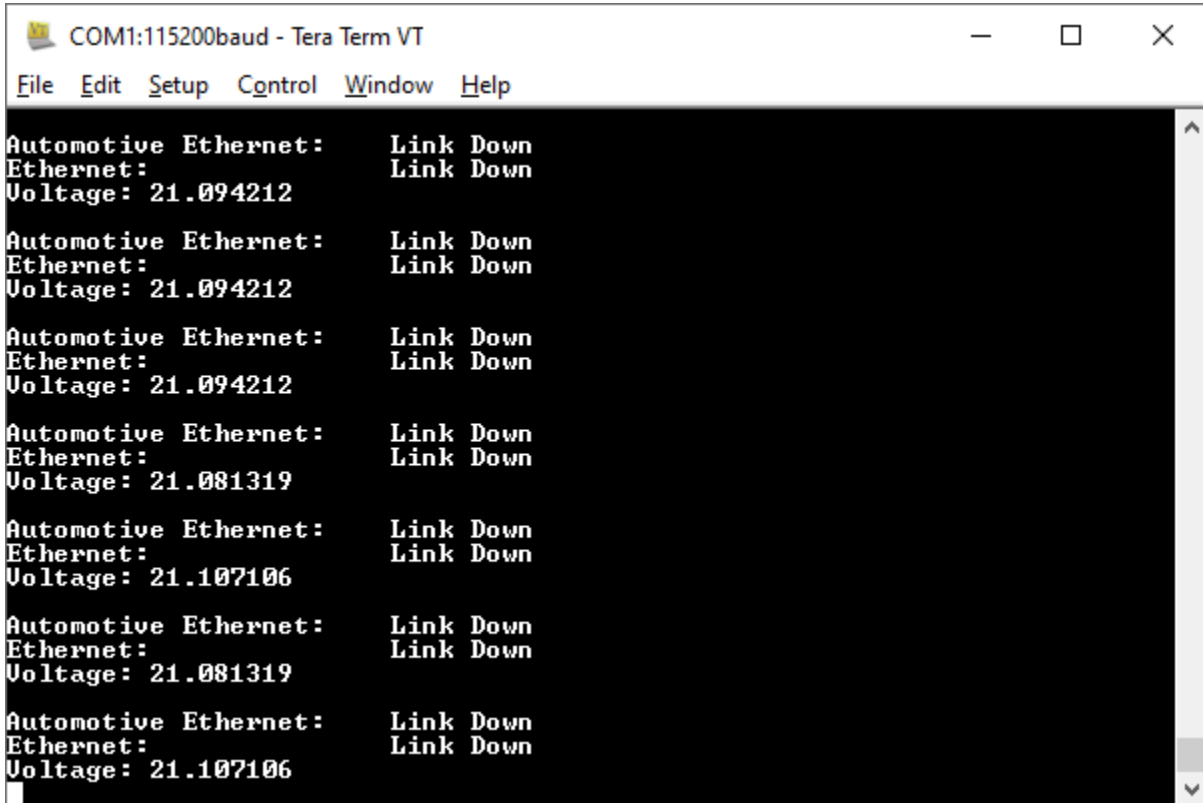

Figure 9 Status Log

3.7 Reboot the Controller

Press 'r' to reboot the converter. This will simply restart the converter. Rebooting the converter will not change the Mode or Speed of the converter. This option is useful to restart the converter through Tera Term.

3.8 Activate bootloader

Press 'b' to activate the bootloader. To activate the bootloader please enter the password: "StartBL".

As shown in the picture below, it will Reboot the convert and the Bootloader will be started. The bootloader ID will be printed, and the bootloader will be activated. Bootloader Menu will give options to load a new Firmware file, to read the current Firmware file, or to reboot the convert to close the bootloader and start the Firmware again.

```
COM1:115200baud - Tera Term VT
File Edit Setup Control Window Help
b
To view or change configuration, please enter the password: *****
Activate bootloader
To activate bootloader please enter password
StartBL
Rebooting the converter. Bootloader will be activated after reboot.
Bootloader_ID is 20023
Bootloader has been activated.
=====
Project       : ENET-AUTOENET-GB Bootloader
Version      : 1.00
Release Date  : November 2021
(c) Axiomatic Technologies Corporation
www.axiomatic.com
=====
Menu
=====
1 - Load New Application Firmware
2 - Show Application Firmware Information Record
3 - Reboot Converter
   Press any key to show this menu again
? █
```

Figure 10 Bootloader Menu

3.8.1 Load New Application Firmware

Press '1' to upload new Firmware. The firmware will be erased. Type 'Yes' only if a valid firmware file is received from Axiomatic Technologies to reflash. Bootloader flags will be erased. Which shows that firmware is erased.

Ready to flash new firmware? Yes/No: "Enter Yes or No and press enter"

Use Menu: **File->Send File...** with **XON/XOFF control**. Select the Firmware File (AF-20023-xx.yy.af) and select the "**Binary File**" options, where xx.yy represents the major and minor version of the firmware, respectively.

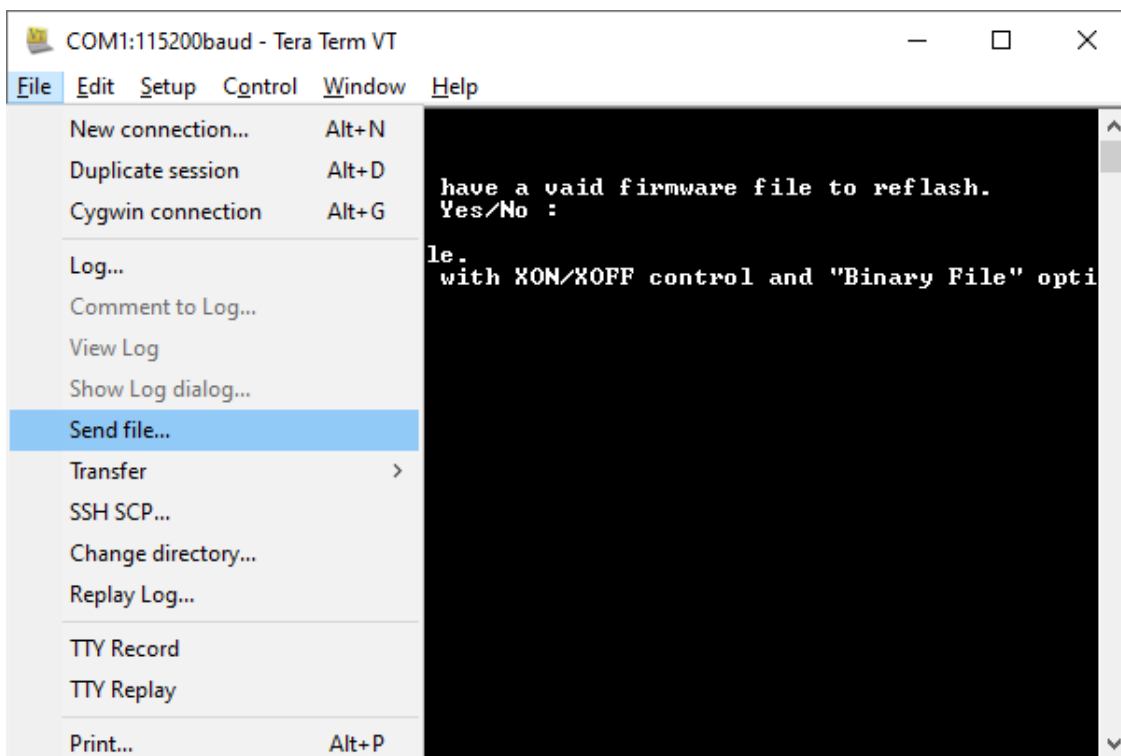

Figure 11 Step 1: File->Send File

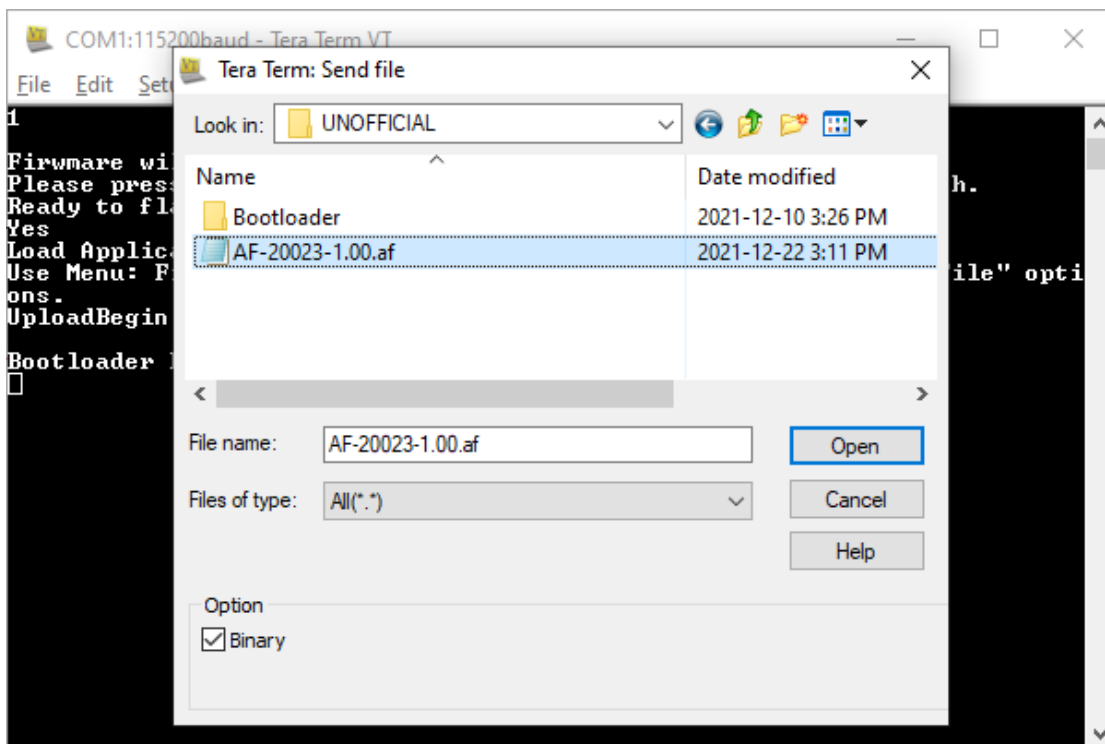

Figure 12 Select "Binary" and Select the Firmware File

4. TECHNICAL SPECIFICATIONS

4.1 Power Supply Input

Table 2 Power Supply Input

Power Supply Input - Nominal	12V, 24Vdc nominal (9...36VDC power supply range)
Protections	Surge protection is provided. Reverse polarity protection up to -50V is provided. Input overvoltage (45V) and input undervoltage (6V) protection are provided. The unit is designed for 12Vdc based load dump.
Power Consumption	135 mA @ 12V; 70 mA @ 24V typical
Power LED	GREEN = Power ON

4.2 Automotive Ethernet

Table 3 Automotive Ethernet Parameters

Port Type	1 port 100BASE-T1//1000BASE-T1 (IEEE 802.3 bw/bp compliant Automatic Polarity Correction Default configuration: Slave (Master mode is configurable via serial interface)												
PHY	Marvell 88Q2112 (100BASE-T1//1000BASE-T1)												
LED's	2 GREEN LEDs for Automotive Ethernet Automotive Ethernet LEDs: <table border="1" style="margin-left: 40px;"> <tr> <td></td> <td>ON</td> <td>BLINK</td> <td>OFF</td> </tr> <tr> <td>LED [0]: Link</td> <td>Link</td> <td></td> <td>No Link</td> </tr> <tr> <td>LED [1]: Activity</td> <td></td> <td>Activity</td> <td>No Activity</td> </tr> </table> <p>Activity: Receive/Transmit</p>		ON	BLINK	OFF	LED [0]: Link	Link		No Link	LED [1]: Activity		Activity	No Activity
	ON	BLINK	OFF										
LED [0]: Link	Link		No Link										
LED [1]: Activity		Activity	No Activity										
Protection	ESD protection for signal lines												
Protocol	Automotive Ethernet Ethernet IEEE 802.3bw for 100BASE-T1 Ethernet IEEE 802.3bp for 1000BASE-T1												

4.3 Ethernet

Table 4 Ethernet Parameters

Port Type	1 port 100BASE-TX/1000BASE-T (IEEE 802.3 compliant) Auto-Negotiation Automatic Polarity Correction
MDIX	Auto-MDI/MDIX (crossover)
PHY	Marvell 88EA1512 (100BASE-TX/1000BASE-T)

Connections	Connector pins	MDI	MDIX (Crossover)
	6/4	BI_DA±	BI_DB±
	5/8	BI_DB±	BI_DA±
	1/7	BI_DC±	BI_DD±
	2/3	BI_DD±	BI_DC±
Protocol	Ethernet IEEE 802.3		
Protection	ESD protection for signal lines		

4.4 Interfaces

Table 5 Converter Interfaces

CAN	1 CAN (SAE J1939) port
User Interface for Reflashing	RS-232
RS-232	1 3-wire RS-232 port Maximum Baud Rate: 400 kBit/s ESD and EFT protection for signal lines
RS-232 User Interface	Any terminal emulator that supports serial communication.
Configurability	Used to configure the unit as Slave (default) or Master functionality

4.5 General Specifications

Table 6 General Specifications

Functionality	Model AX141520 can be configured to acts as a master or a slave.
Microprocessor	STM32F413CGU6
Compliance	CE marking pending
Vibration	Random Vibration: Z-axis tracked vehicle profile (5 hr/axis in all 3 axes) Sinusoidal Component: 8.9 G Sine sweep, 2.5 hr/axis in all 3 axes
Shock	50 g, 5 impacts per test, 6-20 ms impact duration
Operating Conditions	-40 to 60°C (-40 to 140°F) Please see temperature ratings of cables under Mating Wire Harnesses.
Storage Temperature	-40 to 85°C (-40 to 185°F)
Protection	IP67
Weight	0.20 lb. (0.091 kg)
Installation	The typical maximum wire harness length for Automotive Ethernet cabling is 15 m.
Enclosure and Dimensions	See dimensional drawing, Figure 2.0 and 3.0. Nylon 6/6, 30% glass fill UL 94V-0 Ultrasonically welded

4.6 Housing

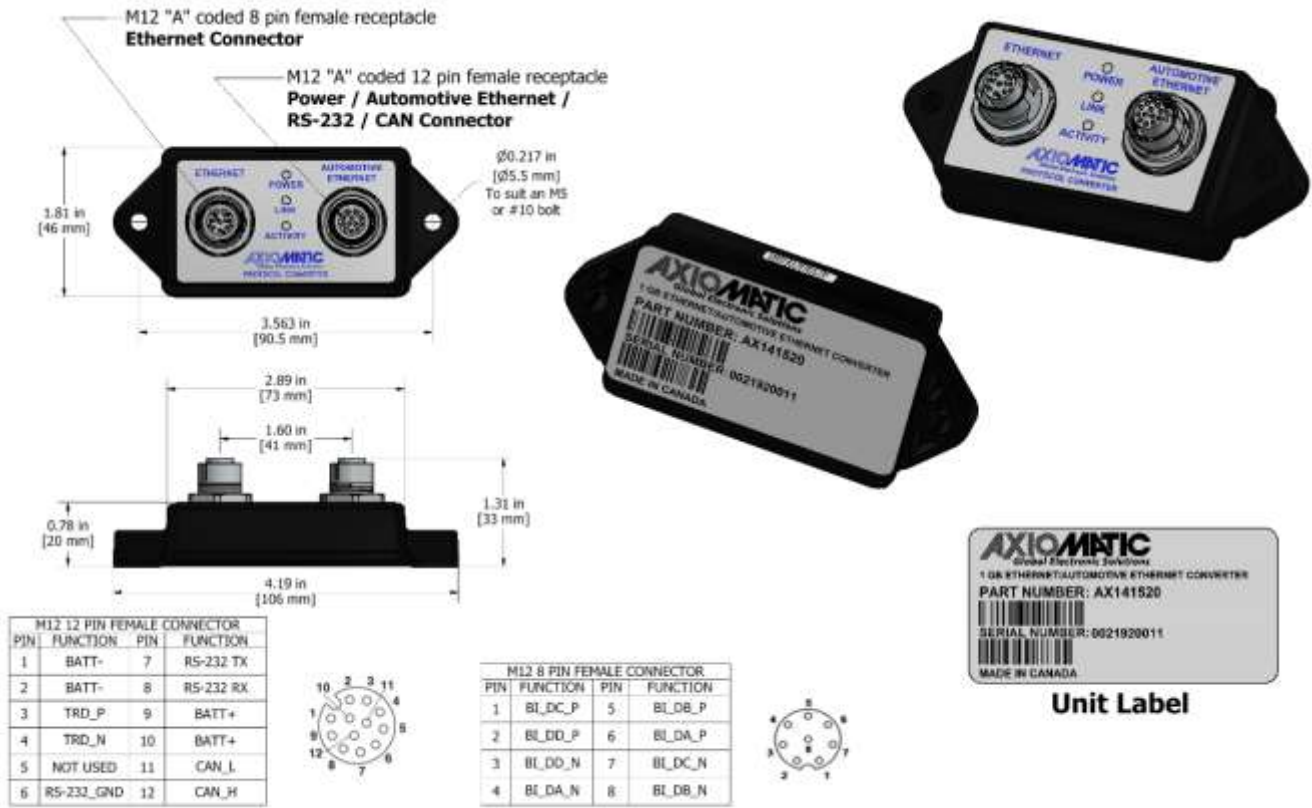
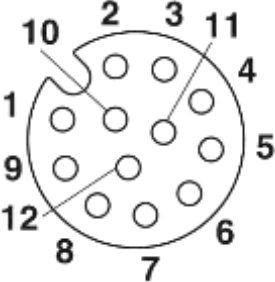



Figure 13 Dimensional Drawing

4.7 Electrical Connectors

Table 7 Electrical Connections and Connectors

Electrical Connections	<p>POWER/ Automotive Ethernet/ RS-232 / CAN Connector 1 Phoenix Contact M12 12-pin connector (A-coded), Female P/N: 1441833 (Connector J2 on the left-hand side)</p> <table border="1" data-bbox="488 386 899 873"> <thead> <tr> <th>PIN #</th> <th>Description</th> </tr> </thead> <tbody> <tr><td>1</td><td>BATT-</td></tr> <tr><td>2</td><td>BATT-</td></tr> <tr><td>3</td><td>TRD_P</td></tr> <tr><td>4</td><td>TRD_N</td></tr> <tr><td>5</td><td>Not Used</td></tr> <tr><td>6</td><td>RS-232_GND</td></tr> <tr><td>7</td><td>RS-232 TX</td></tr> <tr><td>8</td><td>RS-232 RX</td></tr> <tr><td>9</td><td>BATT+</td></tr> <tr><td>10</td><td>BATT+</td></tr> <tr><td>11</td><td>CAN_L</td></tr> <tr><td>12</td><td>CAN_H</td></tr> </tbody> </table>  <p>Ethernet Power Connector 1 Phoenix Contact M12 8-pin connector (A-coded), Female, P/N: 1406117 (Connector J1 on the right-hand side)</p> <table border="1" data-bbox="488 1041 899 1388"> <thead> <tr> <th>PIN #</th> <th>Description</th> </tr> </thead> <tbody> <tr><td>1</td><td>BI_DC_P</td></tr> <tr><td>2</td><td>BI_DD_P</td></tr> <tr><td>3</td><td>BI_DD_N</td></tr> <tr><td>4</td><td>BI_DA_N</td></tr> <tr><td>5</td><td>BI_DB_P</td></tr> <tr><td>6</td><td>BI_DA_P</td></tr> <tr><td>7</td><td>BI_DC_N</td></tr> <tr><td>8</td><td>BI_DB_N</td></tr> </tbody> </table> 	PIN #	Description	1	BATT-	2	BATT-	3	TRD_P	4	TRD_N	5	Not Used	6	RS-232_GND	7	RS-232 TX	8	RS-232 RX	9	BATT+	10	BATT+	11	CAN_L	12	CAN_H	PIN #	Description	1	BI_DC_P	2	BI_DD_P	3	BI_DD_N	4	BI_DA_N	5	BI_DB_P	6	BI_DA_P	7	BI_DC_N	8	BI_DB_N
PIN #	Description																																												
1	BATT-																																												
2	BATT-																																												
3	TRD_P																																												
4	TRD_N																																												
5	Not Used																																												
6	RS-232_GND																																												
7	RS-232 TX																																												
8	RS-232 RX																																												
9	BATT+																																												
10	BATT+																																												
11	CAN_L																																												
12	CAN_H																																												
PIN #	Description																																												
1	BI_DC_P																																												
2	BI_DD_P																																												
3	BI_DD_N																																												
4	BI_DA_N																																												
5	BI_DB_P																																												
6	BI_DA_P																																												
7	BI_DC_N																																												
8	BI_DB_N																																												
Mating Connectors	Mating connectors should meet the following standard for M12 Connectors, IEC 61076-2-101:2012. They should be A-coded.																																												
Mating Wire Harnesses	<p>The following part numbers are available from Axiomatic.</p> <p>AX070535: Ethernet Cable 2 m (6.5 ft.), 8-pin M12 A-coded, Ethernet Jack</p> <p>Note: Cable supplier is Phoenix Contact Network cable NBC-M12MR/2,0-94B/R4AC US – 1406112. The M12 connector on the harness assembly is rated for -20 to +85°C and the RJ45 ethernet jack is rated as -20 to +60°C.</p> <p>AX070533: Cable 1.5 m (5 ft.), 12-pin M12 A-coded, Unterminated Leads</p>																																												

DETAIL A

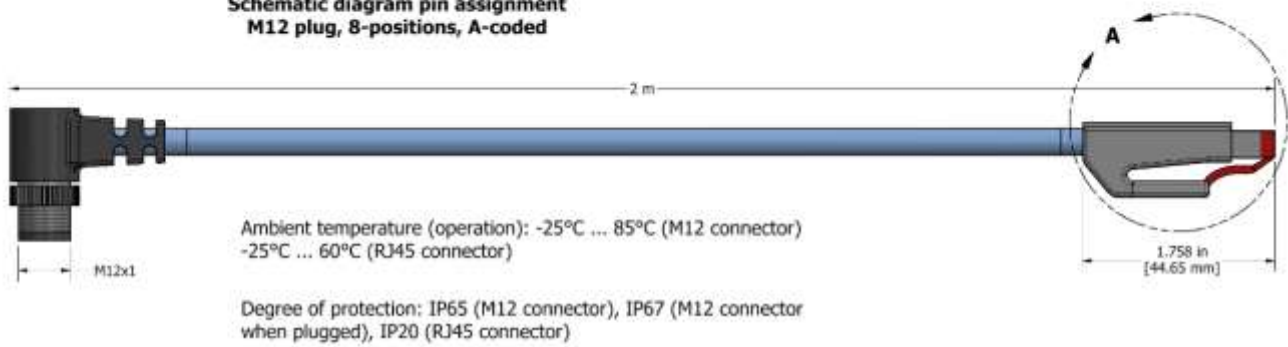
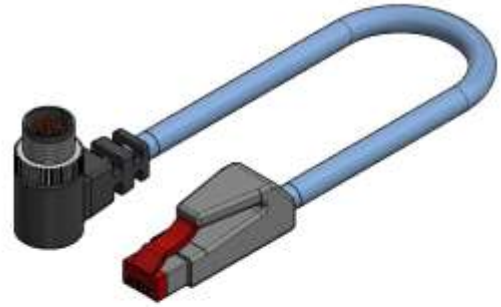
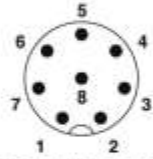
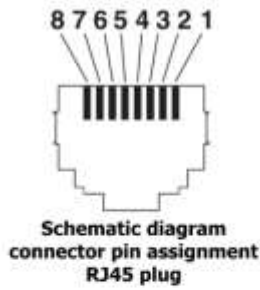
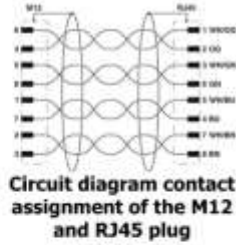
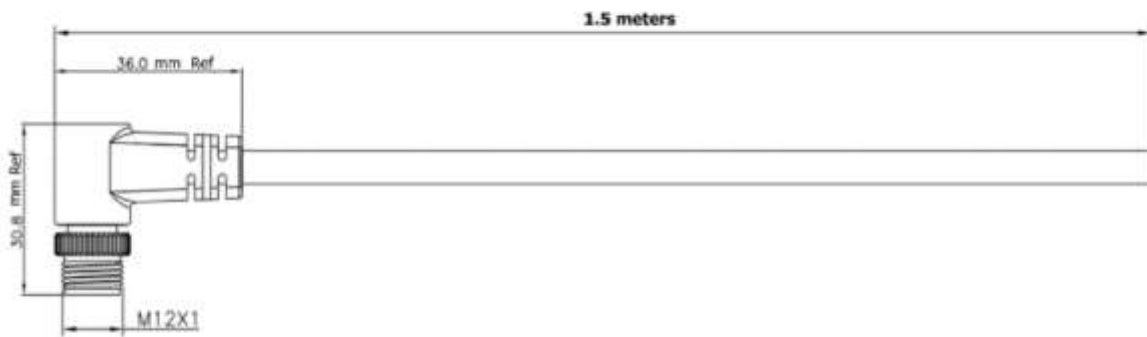

Figure 14 AX070535 Mating Cable



Specifications:
 Standard: IEC 61076-2-101
 Current rating: 4A(3,4,5PIN); 2A(8PIN); 1.5A(12PIN)
 Voltage rating: 250V(3,4,PIN); 60V(5PIN); 30V(8,12PIN)
 Contact Resistance: 5ohm Max.
 Insulation Resistance: 10M ohm Min., DC 450V
 Operating Temperature: -40°C~80°C
 IP Rating: IP67 in Locked Condition

Figure 15 AX070533 Mating Cable

5. VERSION HISTORY

Version	Date	Author	Modifications
-	April 8 th , 2021	Meera Patel	Initial Draft
1.0	February 4 th , 2022	Meera Patel	Completed the User Manual
1A	February 4 th , 2022	Meera Patel	Updated the Firmware Reflashing interface
1B	September 7, 2022	Amanda Wilkins, Peter Yin	Updated PHY spec and user interface details in Specifications section

OUR PRODUCTS

AC/DC Power Supplies
Actuator Controls/Interfaces
Automotive Ethernet Converters
Battery Chargers
CAN Controls, Routers, Repeaters
CAN/WiFi, CAN/Bluetooth, Routers
Current/Voltage Converters
DC/DC Power Converters
Engine Temperature Scanners
Ethernet/CAN Converters,
Gateways, Switches
Fan Drive Controllers
Gateways, CAN/Modbus Protocols
Gyroscope Inclinometers
Hydraulic Valve Controllers
Inclinometers, Triaxial
I/O Controls
LVDT Signal Converters
Machine Controls
Modbus Controls
Motor Controls
Power Supplies, DC/DC, AC/DC
PWM Signal Converters/Isolators
Resolver Signal Conditioners
Service Tools
Signal Conditioners, Converters
Strain Gauge CAN Controls
Surge Suppressors

OUR COMPANY

Axiomatic provides electronic machine control components to the off-highway, commercial vehicle, electric vehicle, power generator set, material handling, renewable energy and industrial OEM markets. ***We innovate with engineered and off-the-shelf machine controls that add value for our customers.***

QUALITY DESIGN AND MANUFACTURING

We have an ISO9001:2015 registered design/manufacturing facility in Canada.

WARRANTY, APPLICATION APPROVALS/LIMITATIONS

Axiomatic Technologies Corporation reserves the right to make corrections, modifications, enhancements, improvements, and other changes to its products and services at any time and to discontinue any product or service without notice. Customers should obtain the latest relevant information before placing orders and should verify that such information is current and complete. Users should satisfy themselves that the product is suitable for use in the intended application. All our products carry a limited warranty against defects in material and workmanship. Please refer to our Warranty, Application Approvals/Limitations and Return Materials Process at <https://www.axiomatic.com/service/>.

COMPLIANCE

Product compliance details can be found in the product literature and/or on axiomatic.com. Any inquiries should be sent to sales@axiomatic.com.

SAFE USE

All products should be serviced by Axiomatic. Do not open the product and perform the service yourself.



This product can expose you to chemicals which are known in the State of California, USA to cause cancer and reproductive harm. For more information go to www.P65Warnings.ca.gov.

SERVICE

All products to be returned to Axiomatic require a Return Materials Authorization Number (RMA#) from sales@axiomatic.com. Please provide the following information when requesting an RMA number:

- Serial number, part number
- Runtime hours, description of problem
- Wiring set up diagram, application and other comments as needed

DISPOSAL

Axiomatic products are electronic waste. Please follow your local environmental waste and recycling laws, regulations and policies for safe disposal or recycling of electronic waste.

CONTACTS

Axiomatic Technologies Corporation
5915 Wallace Street
Mississauga, ON
CANADA L4Z 1Z8
TEL: +1 905 602 9270
FAX: +1 905 602 9279
www.axiomatic.com
sales@axiomatic.com

Axiomatic Technologies Oy
Höytämöntie 6
33880 Lempäälä
FINLAND
TEL: +358 103 375 750
FAX: +358 3 3595 660
www.axiomatic.com
salesfinland@axiomatic.com